

Little League® Baseball and Softball



Approved Double Elimination Tournament Brackets for Baseball and Softball Tournaments

Two defeats eliminate an entry. The losers of games in the Winners' Bracket move into specific places in the Losers' Bracket. The two teams that advance the farthest in each bracket meet for the championship. Should the Losers' Bracket finalist defeat the Winners' Bracket finalist, the two teams are re-matched for the championship. Consult the current information on schedules, byes, and forfeits. District Administrators/ Tournament Directors should photocopy these pages for use annually.

Note: When scheduling is complete, all schedules are to be provided to the appropriate Headquarters office for approval by July 1, BEFORE the tournament begins. Once the tournament is played, completed brackets (with financial statement) are mailed to the appropriate Headquarters office. Consult the current Tournament Rules and Guidelines (printed in Rulebooks) for specific information on scheduling, byes and forfeits.

FREQUENTLY ASKED QUESTIONS

Here are some answers to the most common questions we receive at Little League Headquarters each year regarding Tournaments.

Q: Can a local Little League waive its rights to a player who lives within its boundaries, allowing that player to participate in another Little League program?

A: A local Little League does not have the authority to waive such rights. **ONLY THE CHARTER COMMITTEE IN WILLIAMSPORT HAS THIS AUTHORITY.** (See “CHARTER COMMITTEE/WAIVERS OF RULES AND REGULATIONS” in the Rulebooks). If the Charter Committee votes to grant a waiver, the District Administrator will be informed in writing. Waivers, if granted, are for the current season only.

Q: Can a child who does not have residence within a league’s boundaries play in that league for the regular season only, provided he/she is not eligible for Tournament Play (all stars)?

A: No. However, the local league may request a waiver, listing all circumstances that warrant such a waiver. Only the Charter Committee in Williamsport can make the final decision. (See “CHARTER COMMITTEE/WAIVERS OF RULES AND REGULATIONS” in the Rulebooks). If the Charter Committee votes to grant a waiver, the District Administrator will be informed in writing. Waivers, if granted, are for the current season only.

Q: If a parent signs a notarized statement granting temporary custody of a child to a friend or other family member, can that friend or family member’s residence be used for registering a child to play in Little League?

A: The **ONLY** acceptable documentation regarding a change of custody is **COURT-ORDERED CUSTODY**, a decree issued by a judge who has jurisdiction in the matter.

Q: Does the District Administrator have the authority to grant a waiver of a rule or regulation? Example: Could the District Administrator give permission for a local league to register players whose residence is outside the league’s boundaries?

A: ANY waiver of a rule or regulation can only be made by the Charter Committee in Williamsport. No other person or group has this authority. If the Charter Committee votes to grant a waiver, the District Administrator will be informed in writing. Waivers, if granted, are for the current season only.

Q: What is the required method for selecting Tournament (all star) teams?

A: There is no required method. The local league board of directors decides annually on the selection method. However, a suggested method is included in the Tournament Rules and Guidelines section of the Rulebooks.

Q: What is the difference between Regular Season and Tournament Play (all stars)?

A: During the Regular Season, every eligible child in the league’s boundaries is given the opportunity to try out and participate on a team. Generally, the Regular Season begins in the spring and can last until September, but the start/end dates for the Regular Season vary. In Tournament Play, a league holding charters in the proper divisions may enter teams in up to five baseball and five softball divisions in the International Tournament. Tournament Play begins around July 1 and ends in late August with World Series tournaments in eight divisions of baseball and softball. Many of the rules and regulations are the same for Regular Season and Tournament Play. However, there are some exceptions, detailed in the Tournament Rules and Guidelines section of the Rulebooks. Some Districts have “Special Games” tournaments (sometimes called “Strong Team Tournaments” or “Tournament of Champions.”) Special Games require specific written approval from Little League Headquarters. Little League also offers a “Second Season” program, sometimes called “Fall Ball” or “Winter League,” with details available at your Regional Center, listed on page 2 or 3 of the Rulebooks.

Two Teams

Division: _____

Site(s): _____

Update phone: _____

Next level: _____

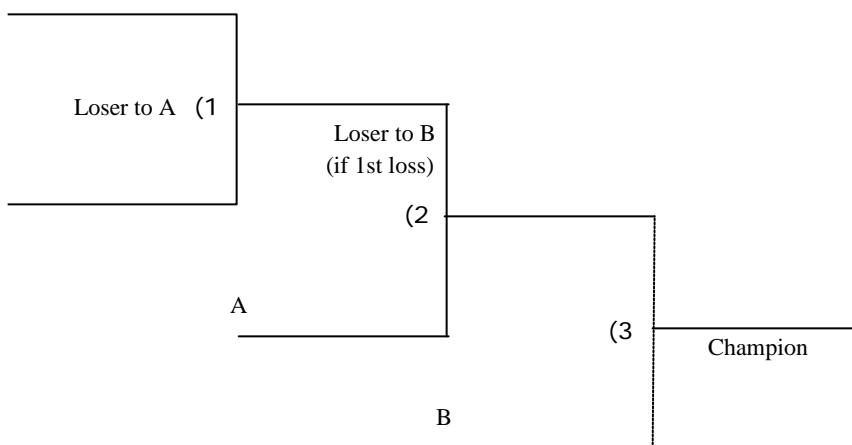

Three Teams

Division: _____

Site(s): _____

Update phone: _____

Next level: _____

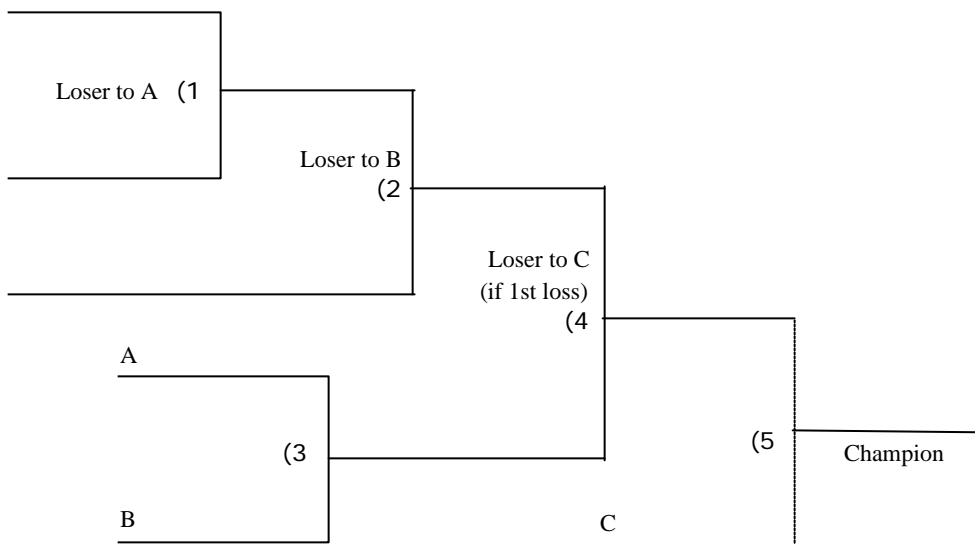

Four Teams

Division: _____

Site(s): _____

Update phone: _____

Next level: _____

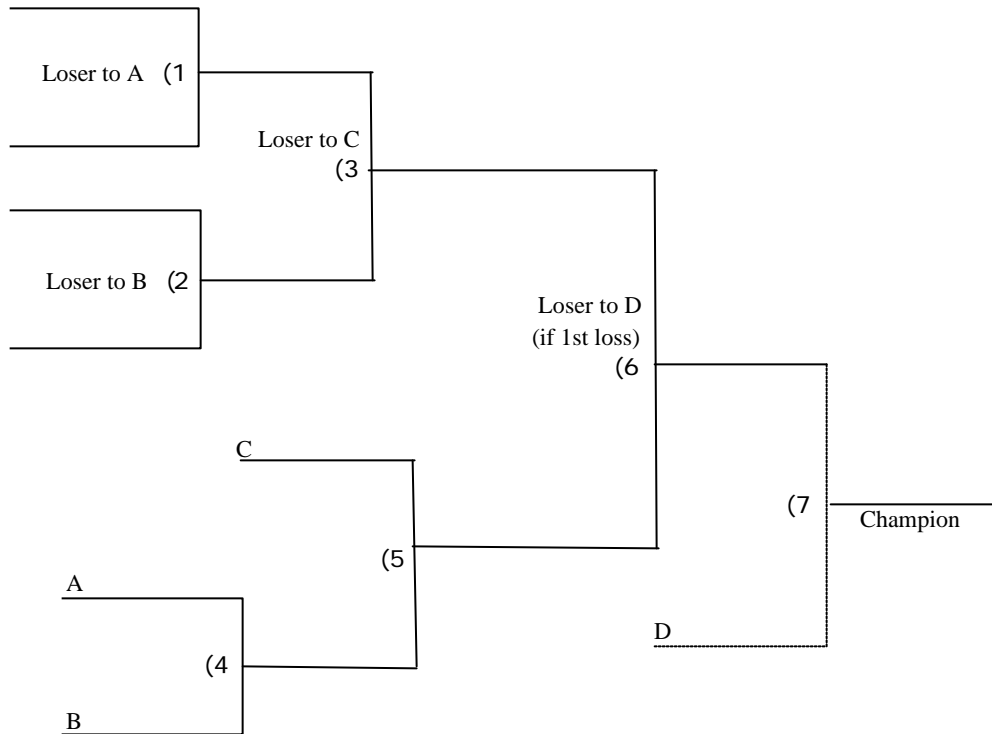

Five Teams

Division: _____

Site(s): _____

Update phone: _____

Next level: _____

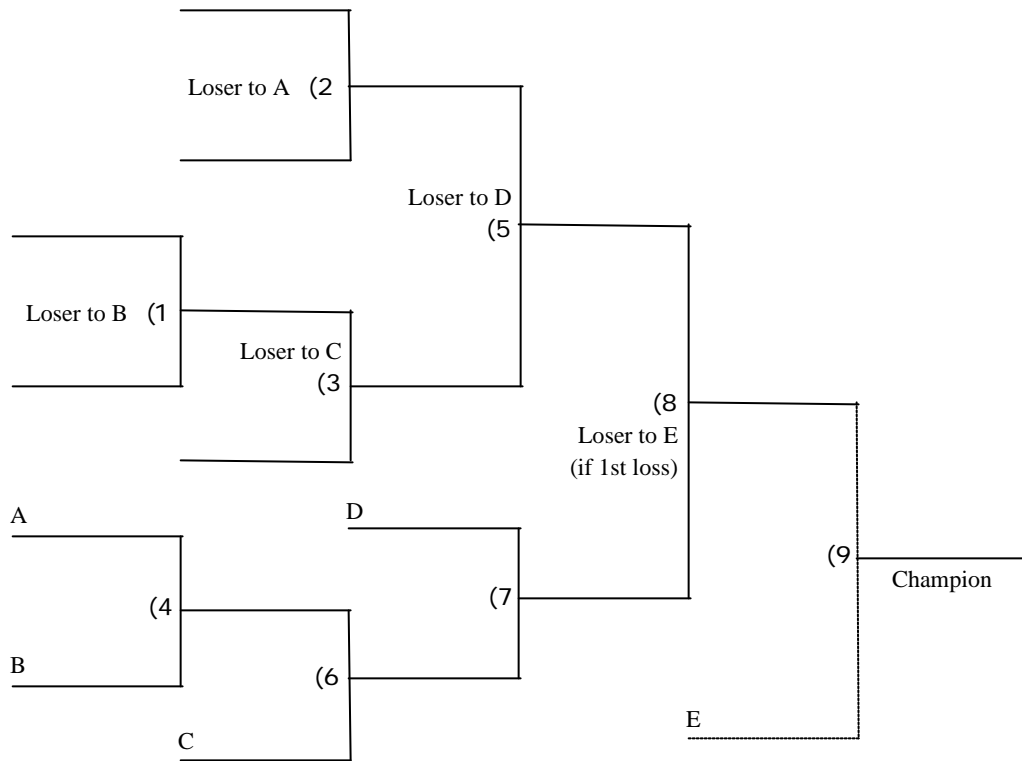

Six Teams

Division: _____

Site(s): _____

Update phone: _____

Next level: _____

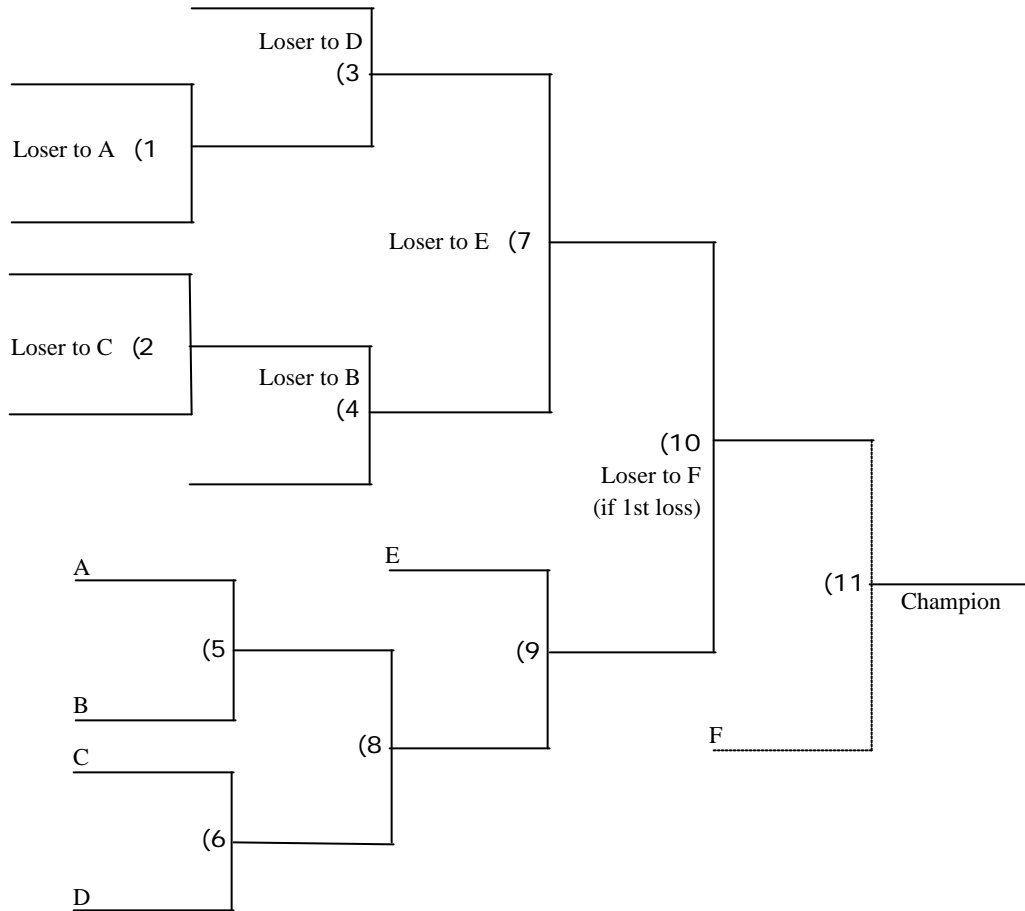

Seven Teams

Division: _____

Site(s): _____

Update phone: _____

Next level: _____

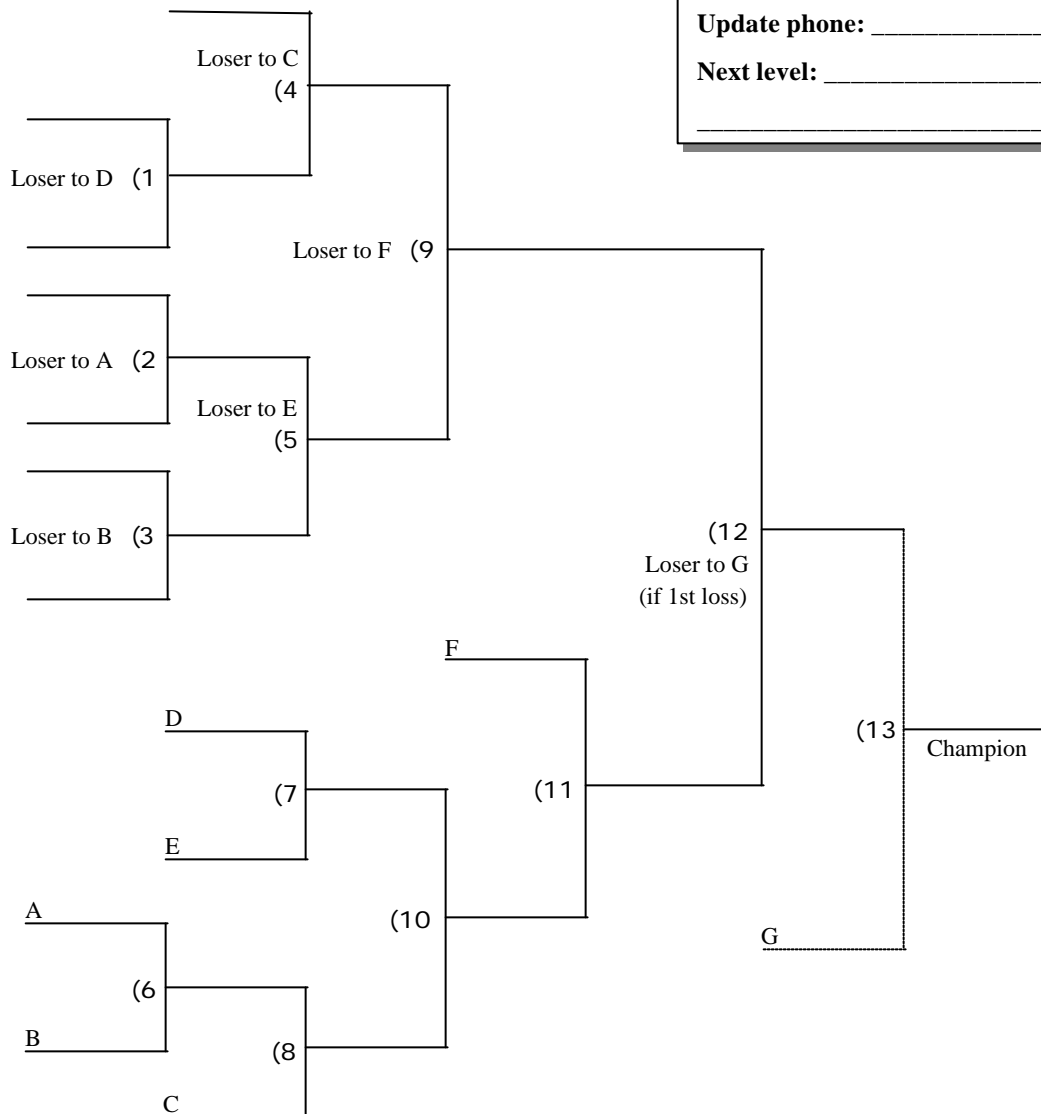

Eight Teams

Division: _____

Site(s): _____

Update phone: _____

Next level: _____

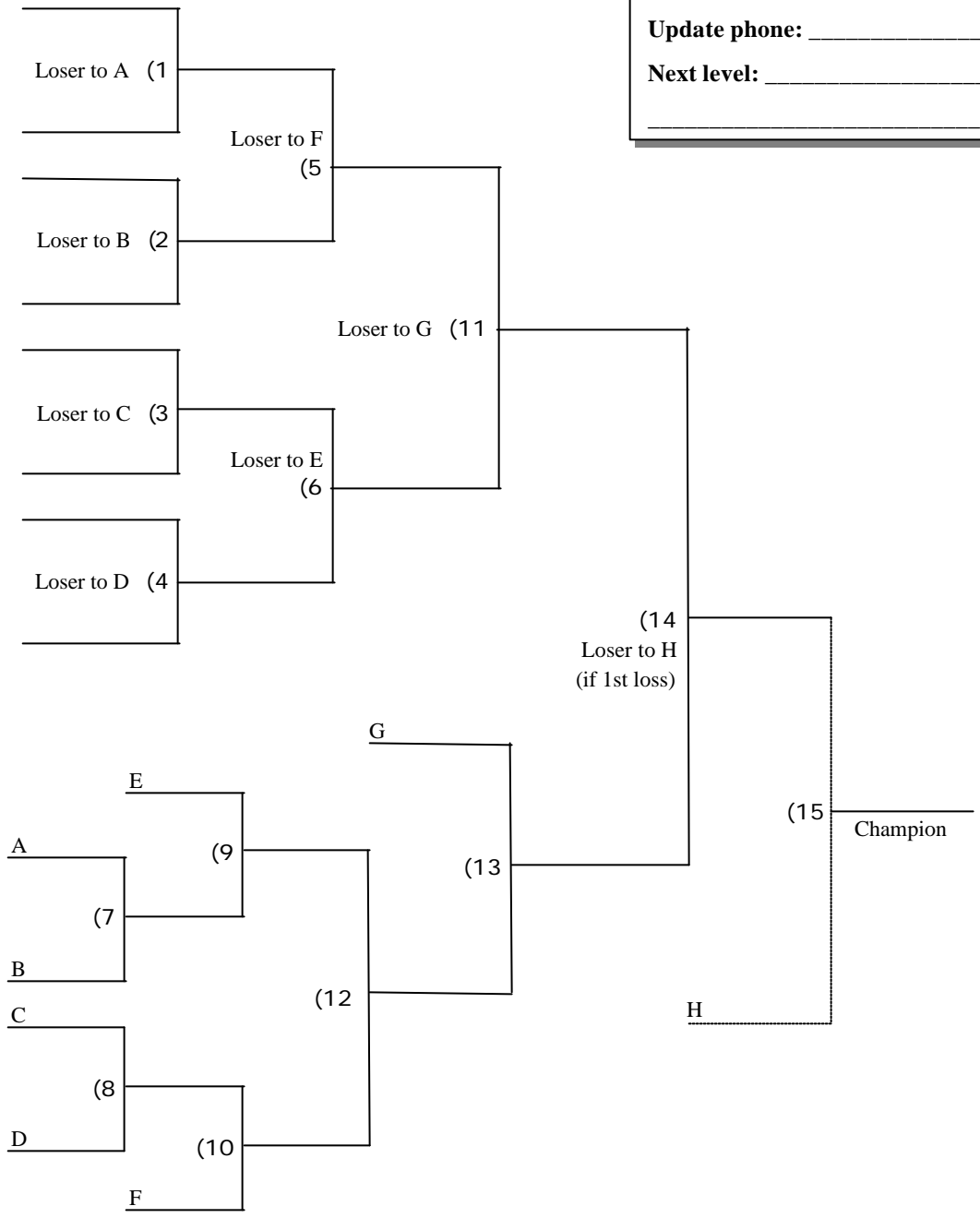

Nine Teams

Division: _____
Site(s): _____

Update phone: _____
Next level: _____

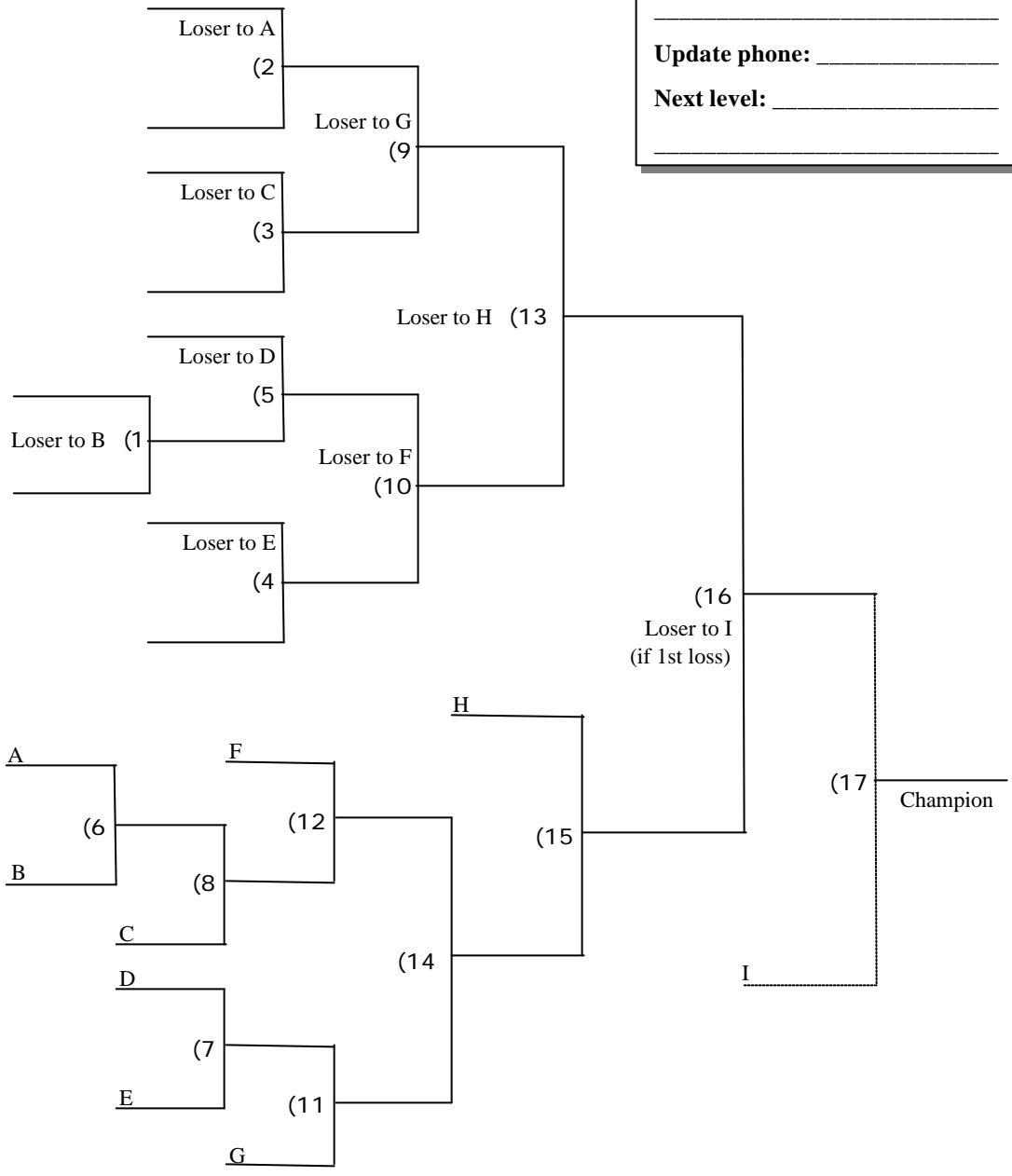

Ten Teams

Division: _____
Site(s): _____

Update phone: _____
Next level: _____

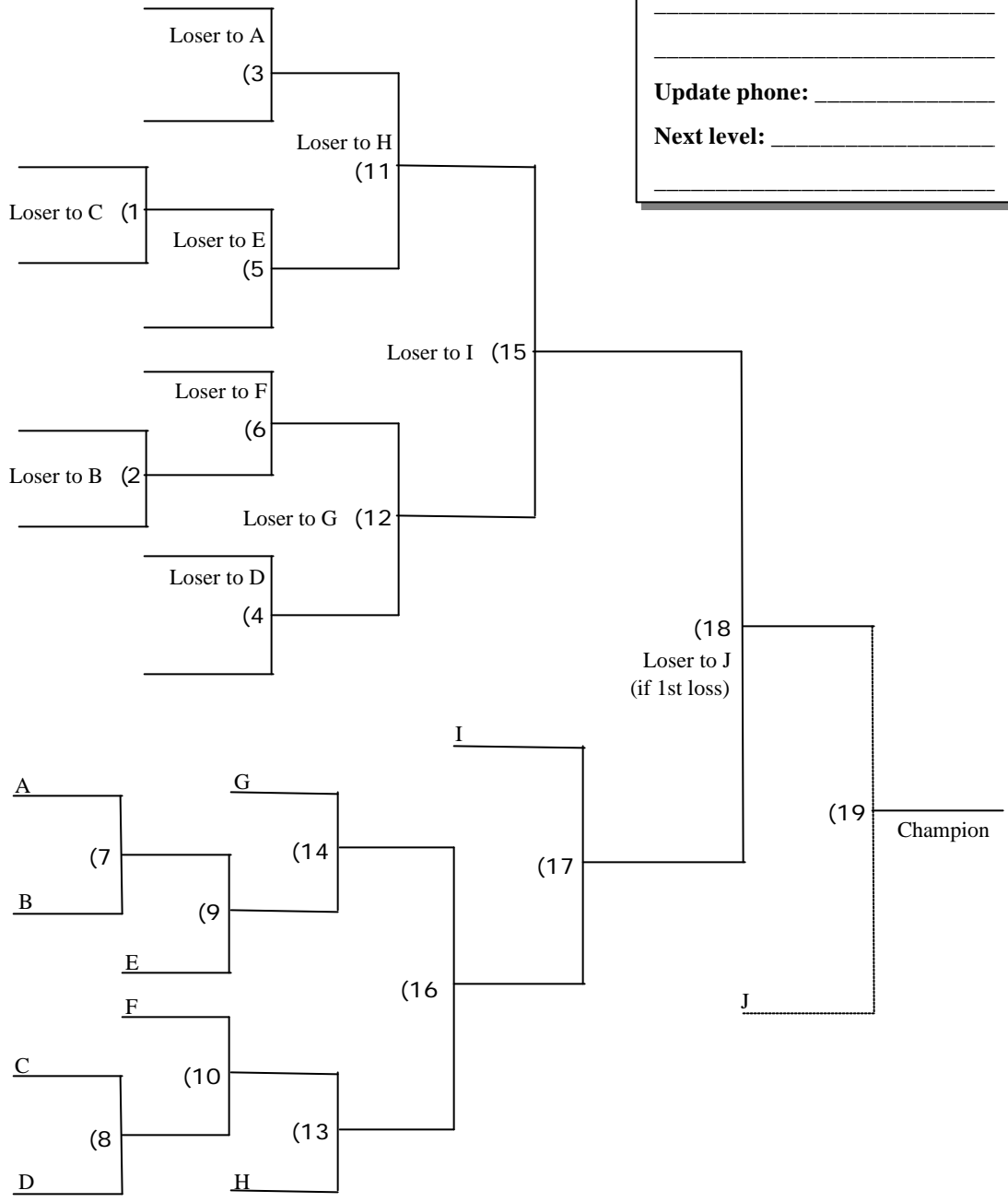

Eleven Teams

Division: _____

Site(s): _____

Update phone: _____

Next level: _____

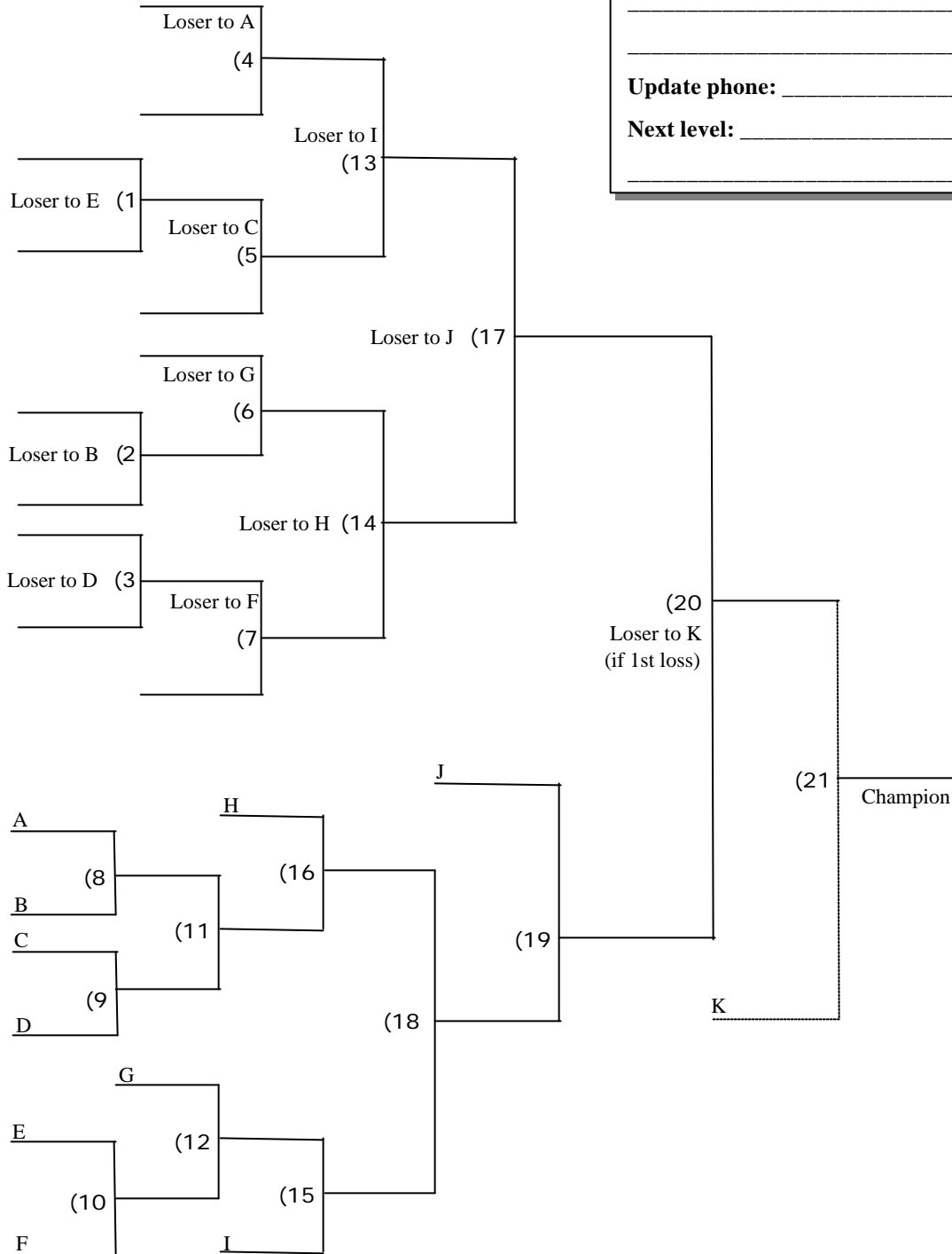

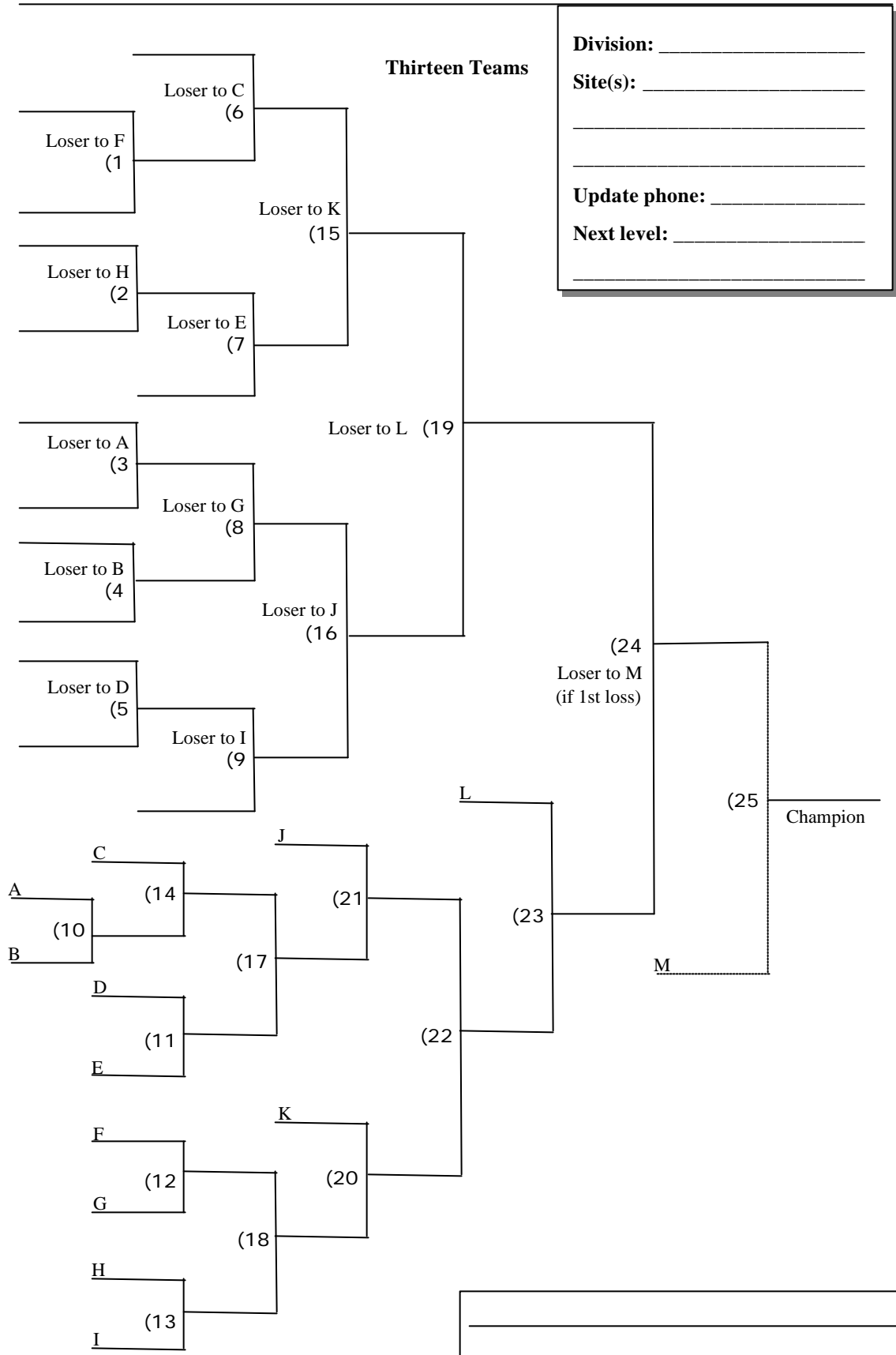

Thirteen Teams

Division: _____

Site(s): _____

Update phone: _____

Next level: _____

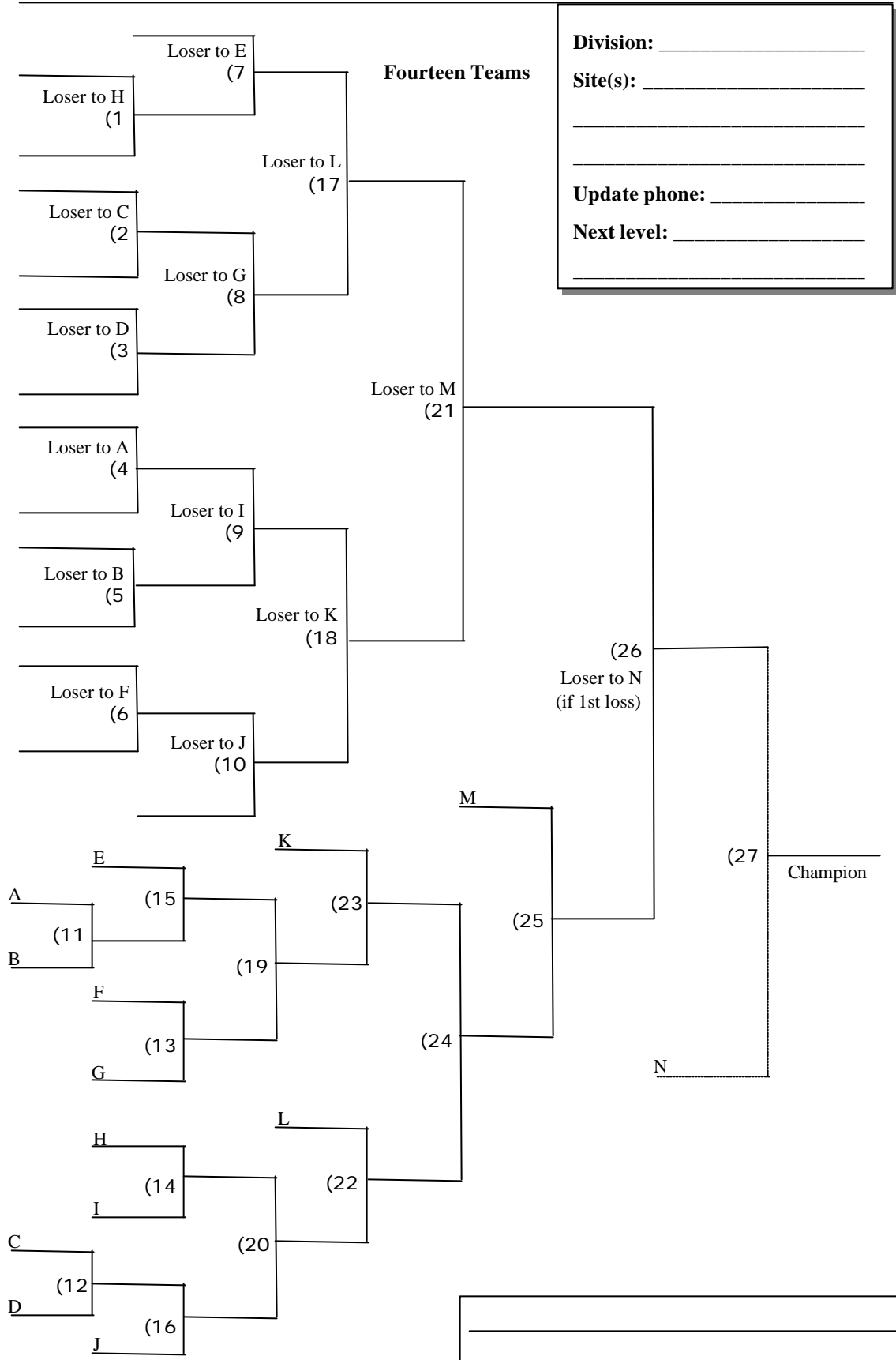

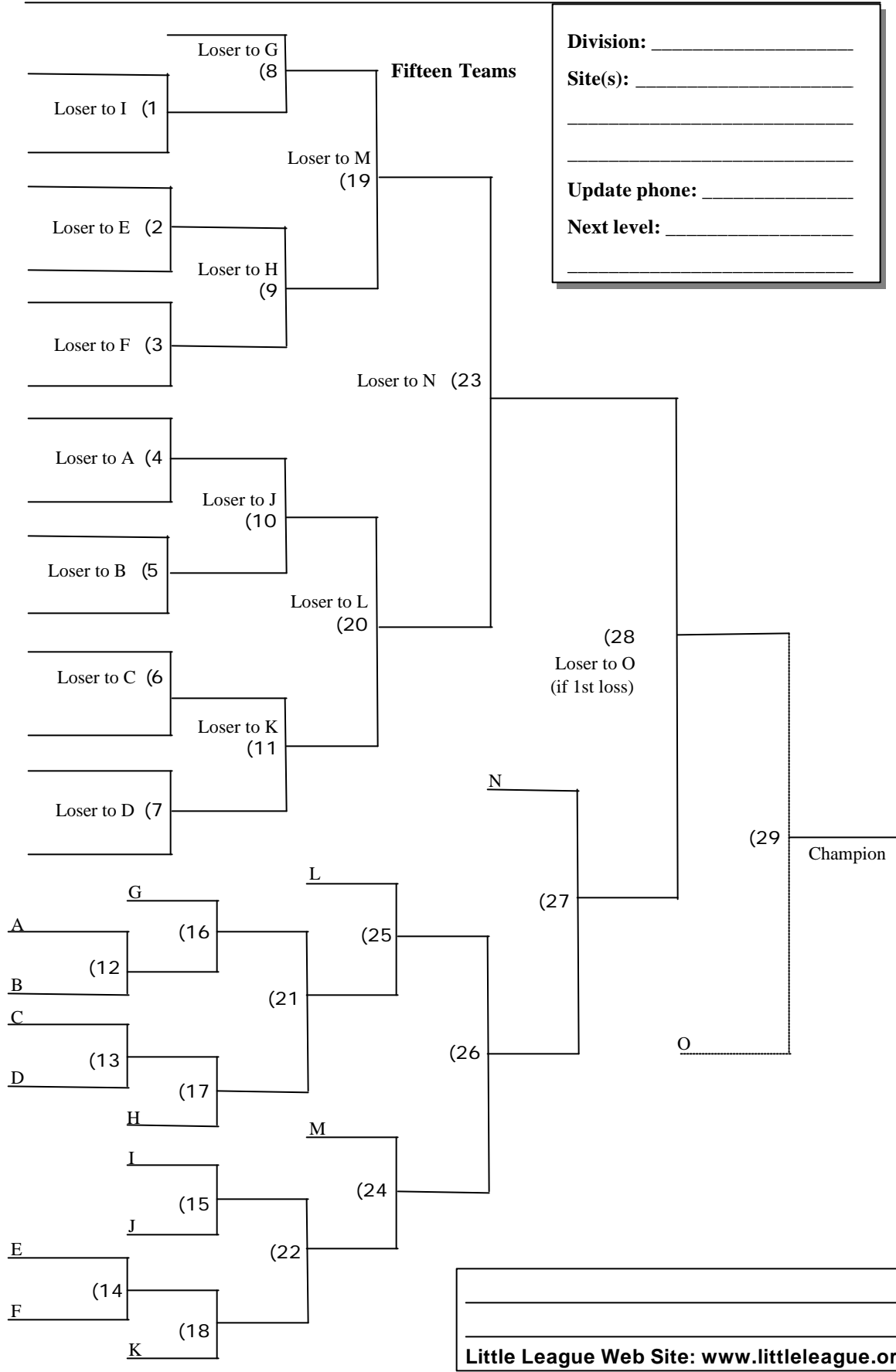

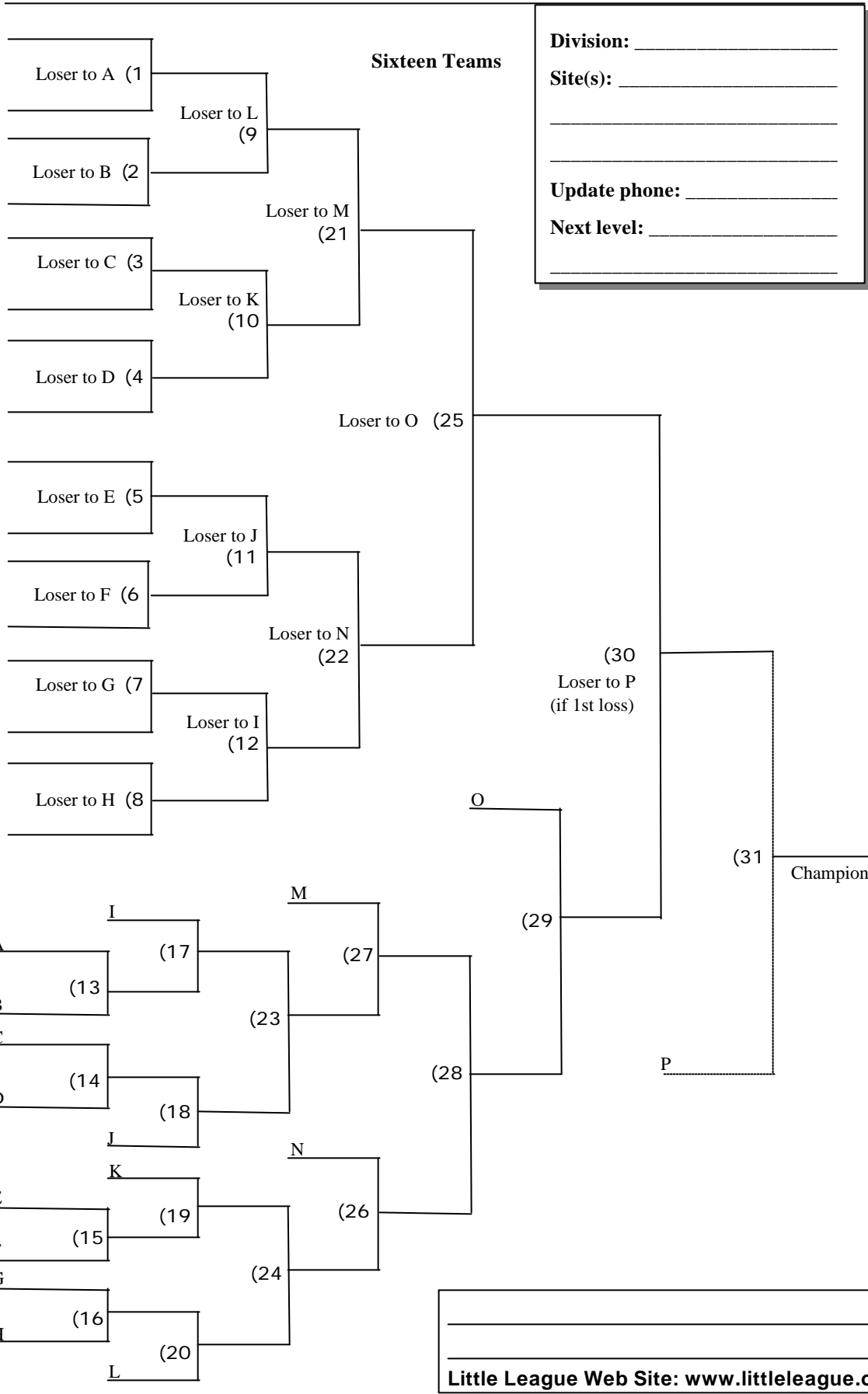

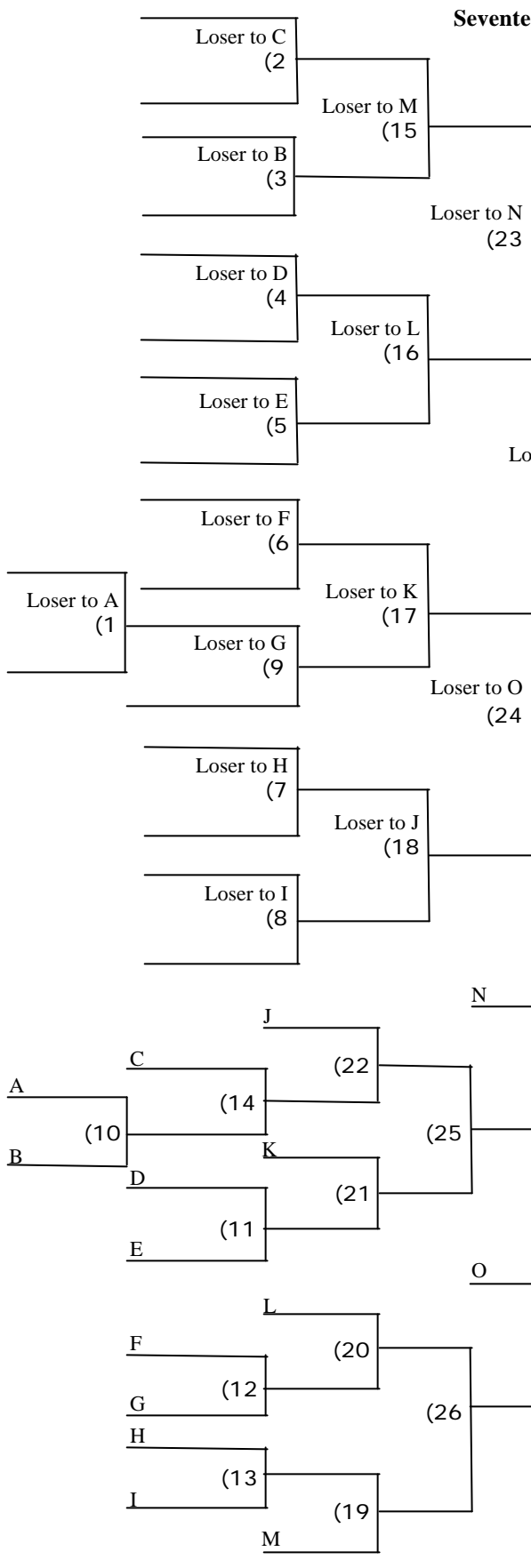
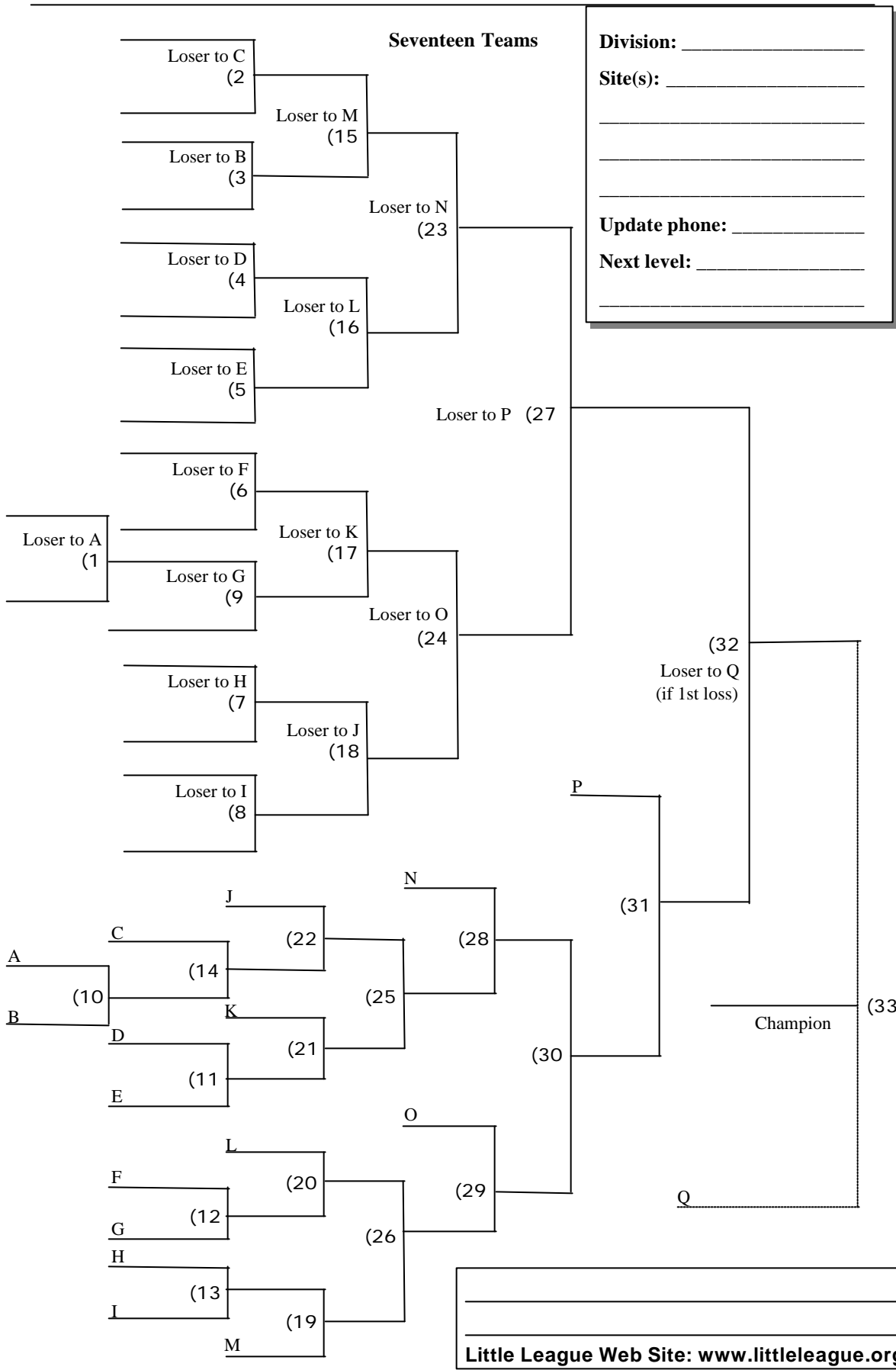

Little League Web Site: www.littleleague.org

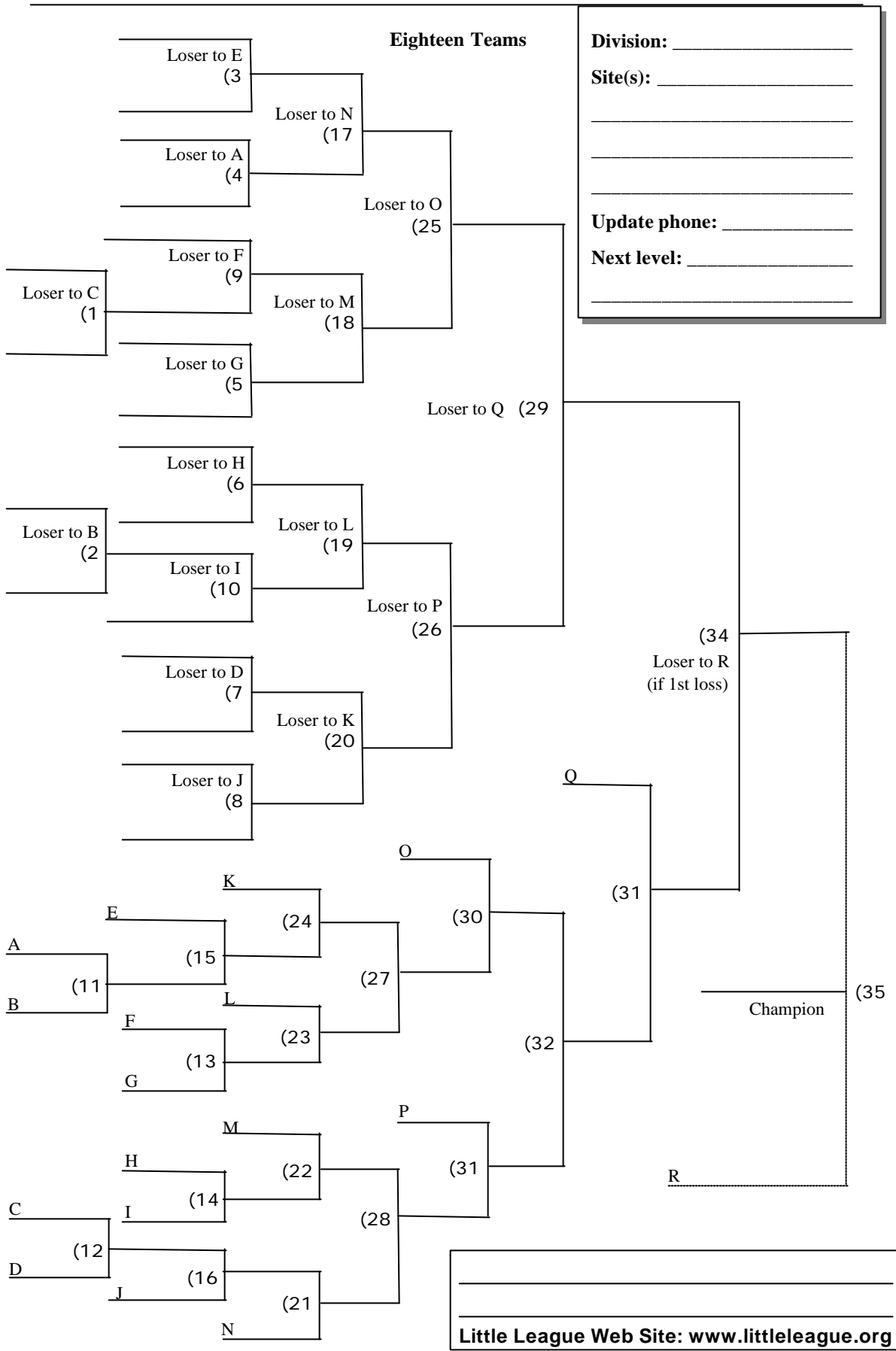

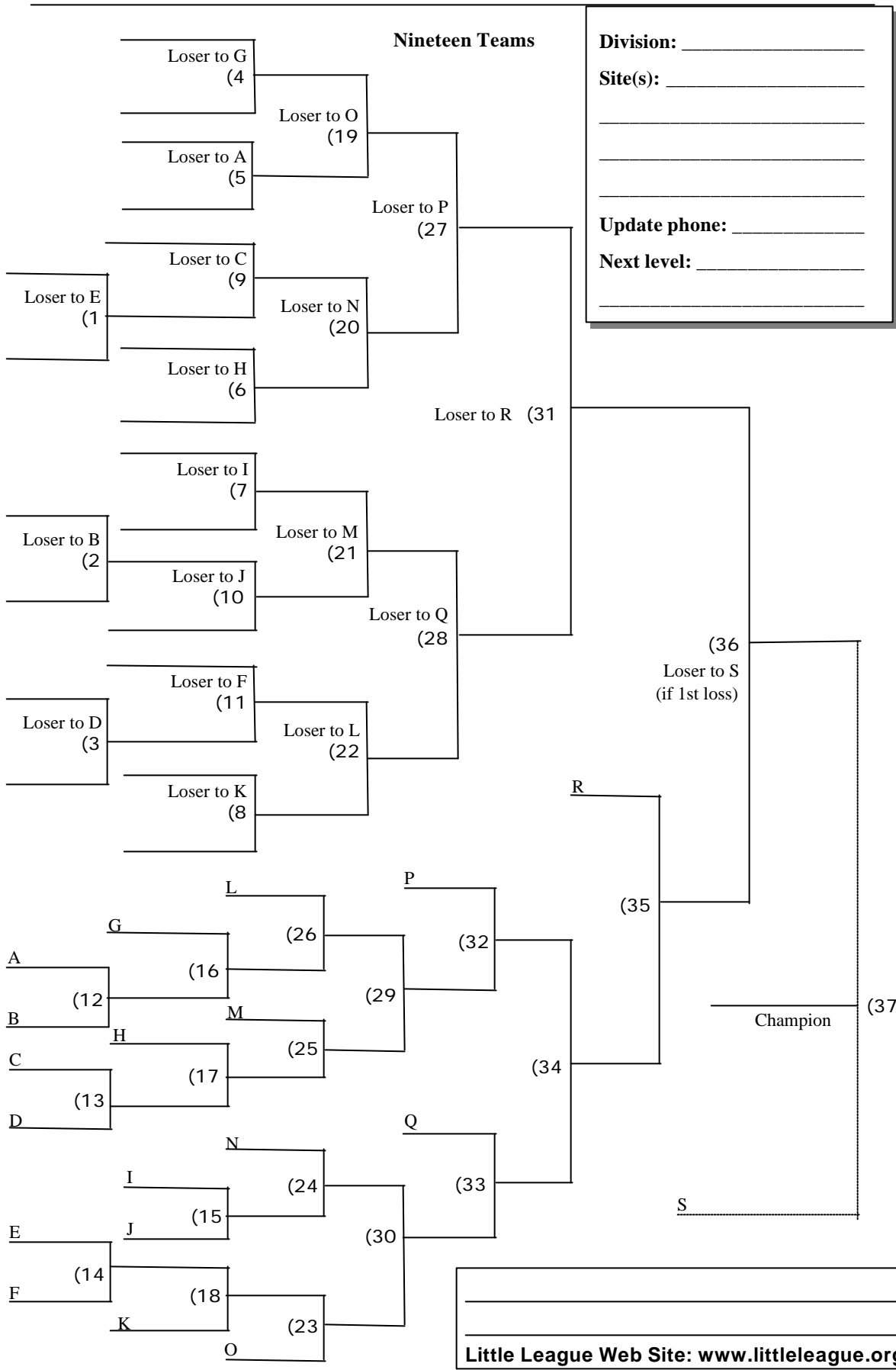

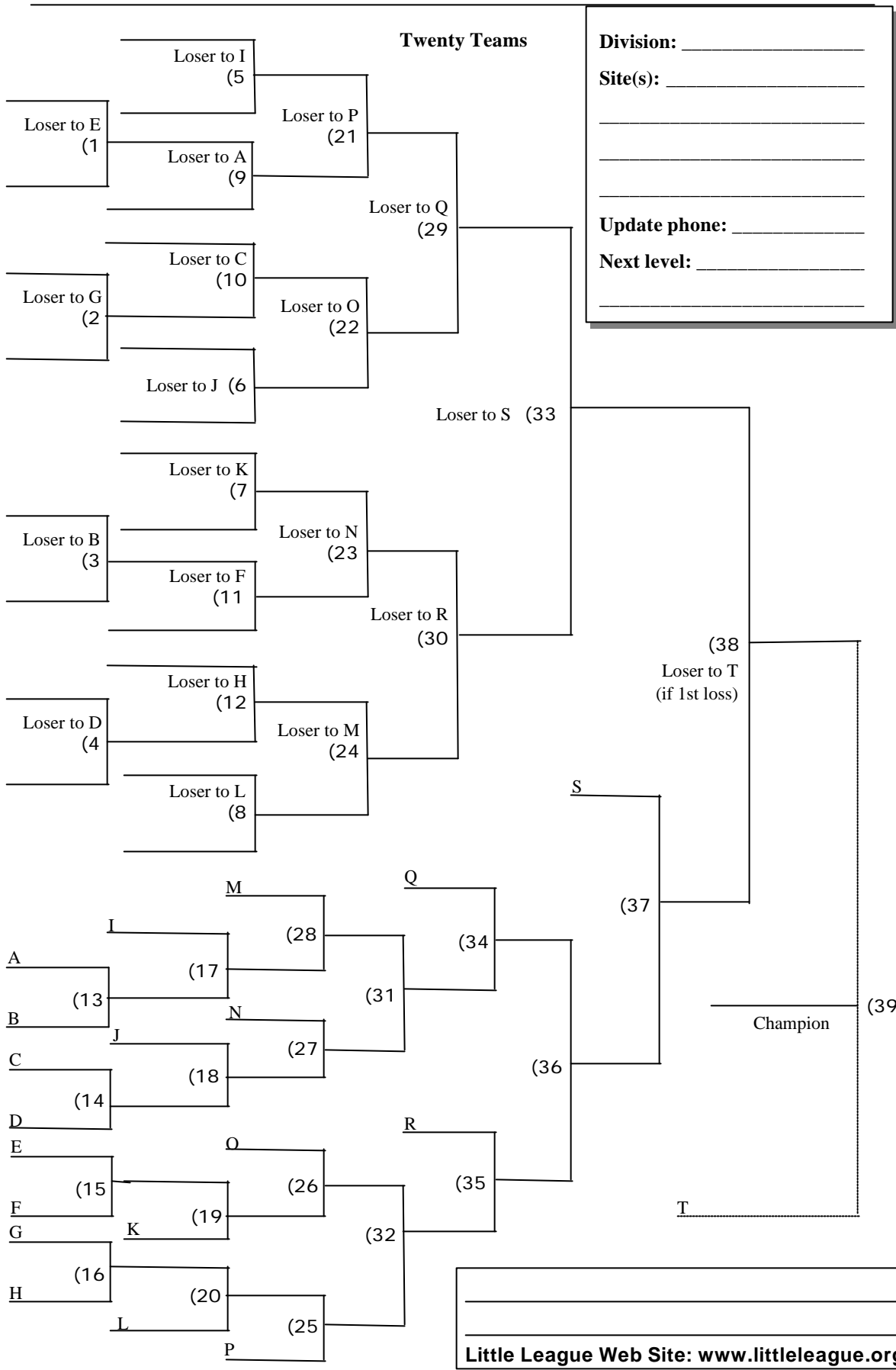

**Thirty Two Teams
(Winners' Bracket)**

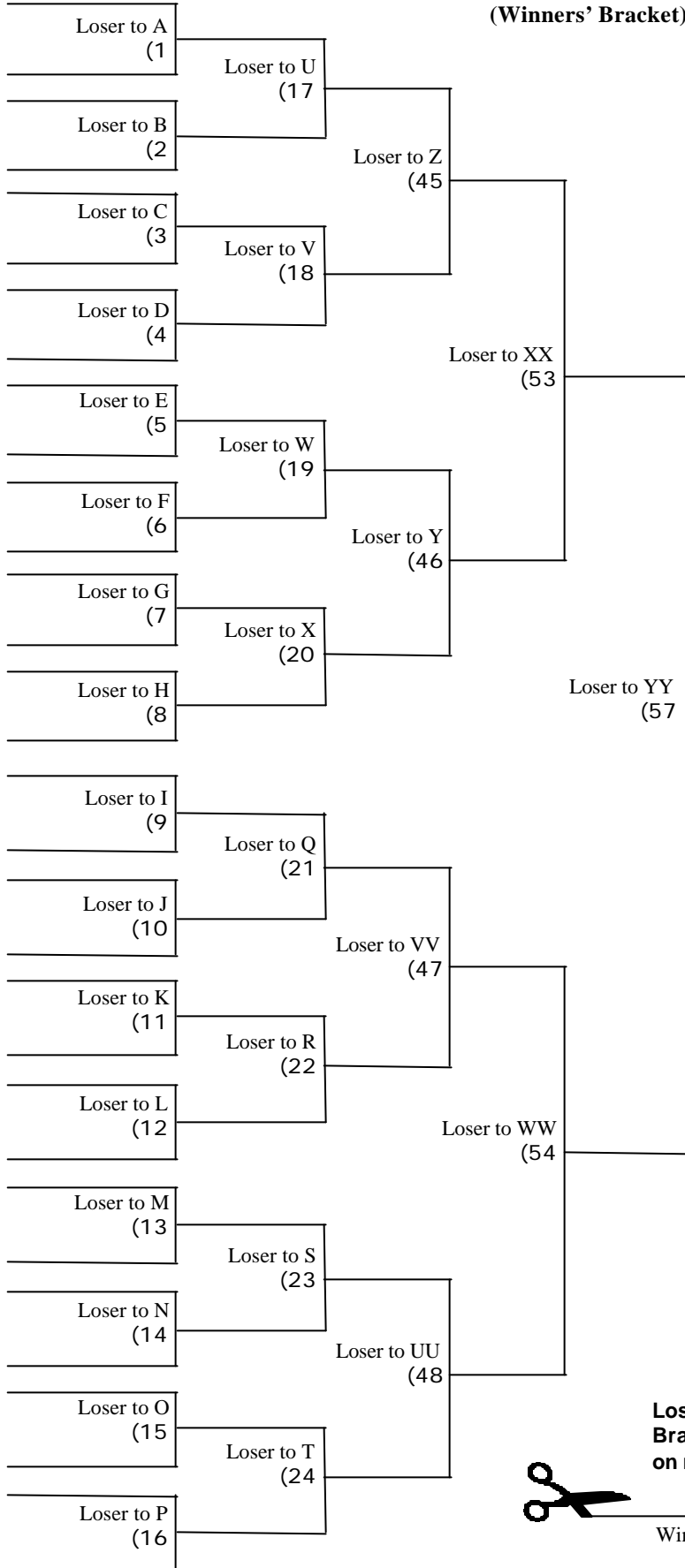

Division: _____
Site(s): _____

Update phone: _____
Next level: _____

Little League Web Site:
www.littleleague.org



Winner Game 61

**Losers' Bracket
on next page**

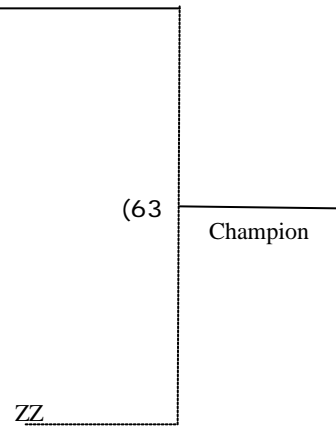

Little League Web Site:
www.littleleague.org

**Thirty Two Teams
(Losers' Bracket)**

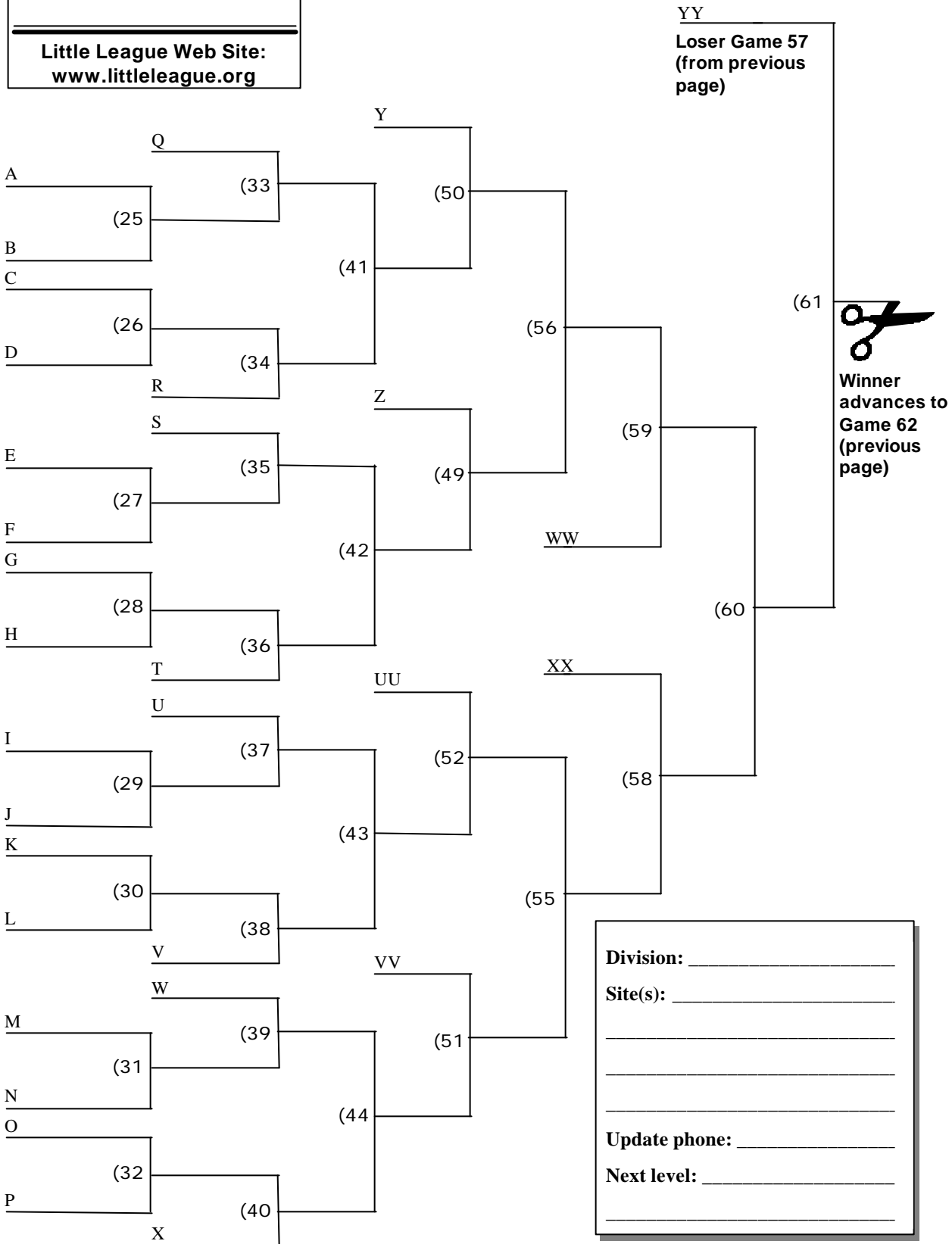

Little League Web Site:
www.littleleague.org

**Thirty One Teams
(Losers' Bracket)**

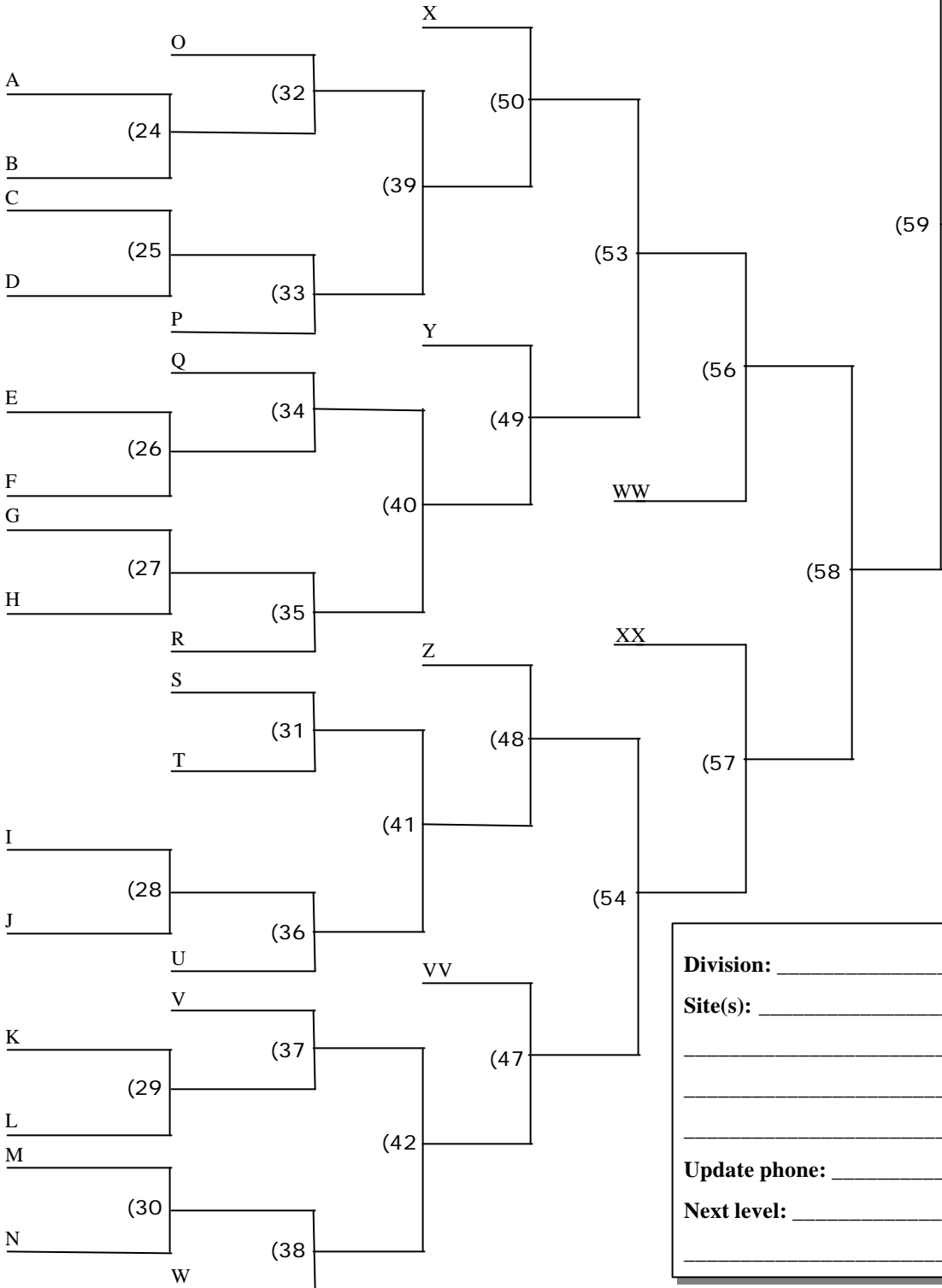

YY
Loser Game 55
(from previous page)

(59) 
Winner advances to
Game 60
(previous page)

Division: _____
 Site(s): _____

 Update phone: _____
 Next level: _____

**Thirty Teams
(Winners' Bracket)**

Division: _____

Site(s): _____

Update phone: _____

Next level: _____

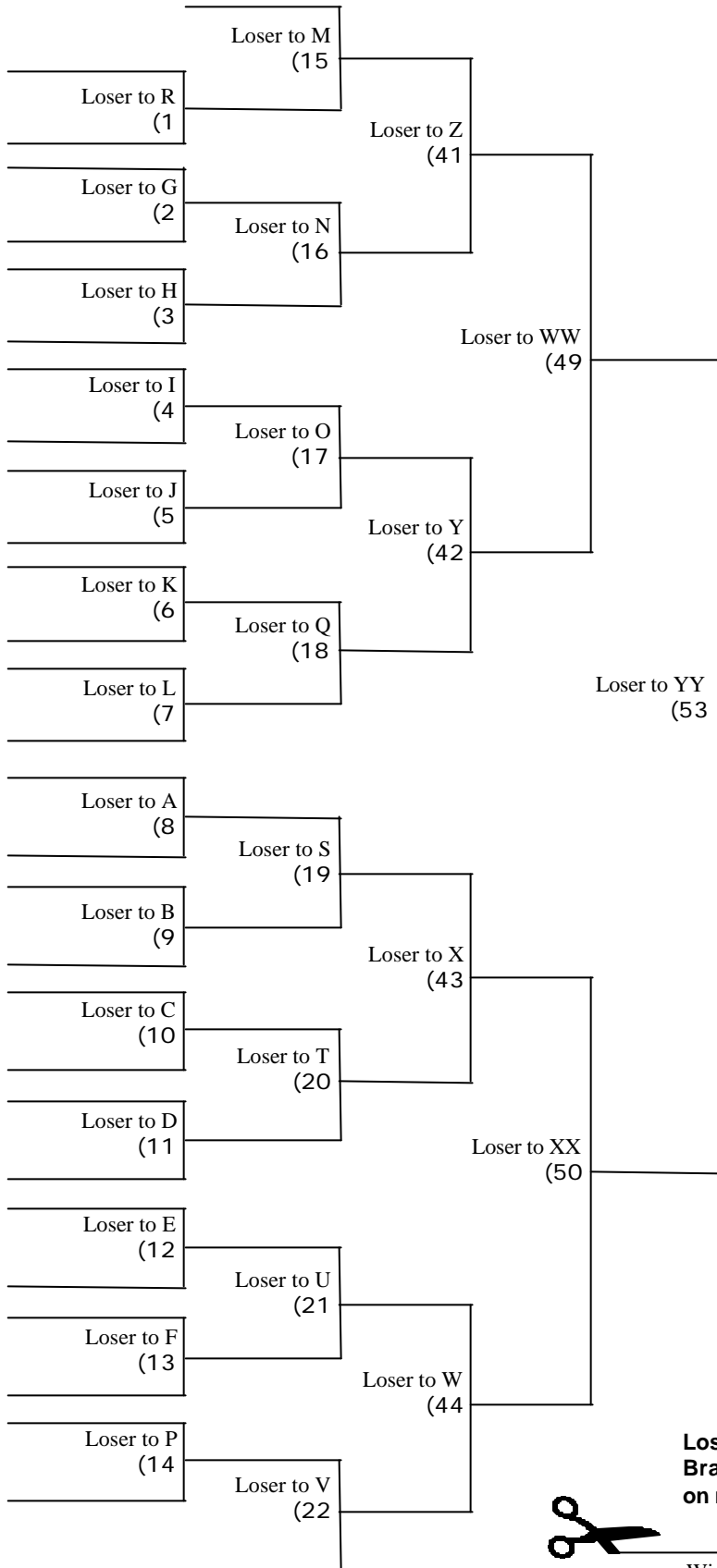

Little League Web Site:
www.littleleague.org

**Losers' Bracket
on next page**



Winner Game 57

Little League Web Site:
www.littleleague.org

**Thirty Teams
(Losers' Bracket)**

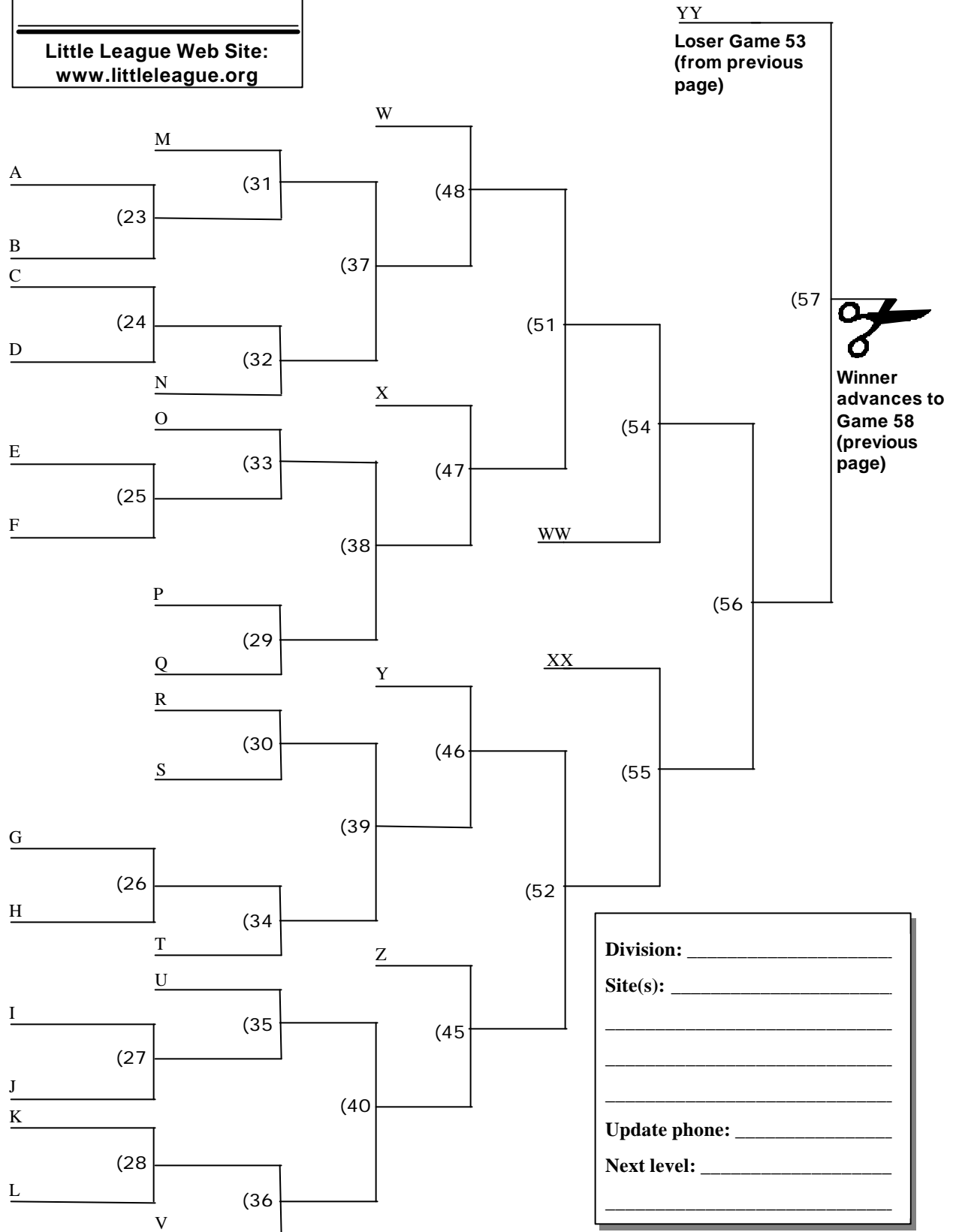

**Twenty Nine Teams
(Winners' Bracket)**

Division: _____

Site(s): _____

Update phone: _____

Next level: _____

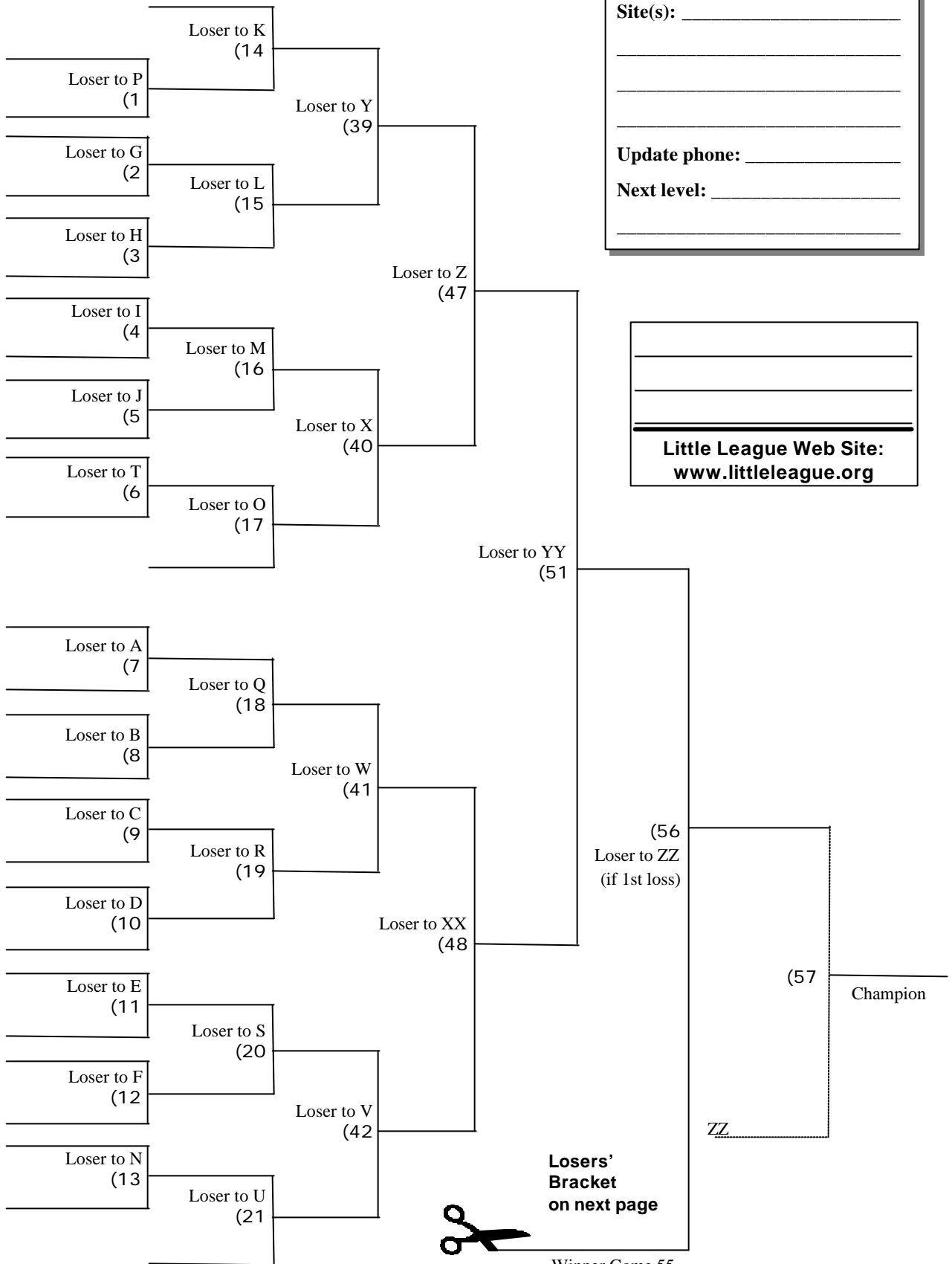

Little League Web Site:
www.littleleague.org



**Losers' Bracket
on next page**

Winner Game 55

Little League Web Site:
www.littleleague.org

**Twenty Nine Teams
(Losers' Bracket)**

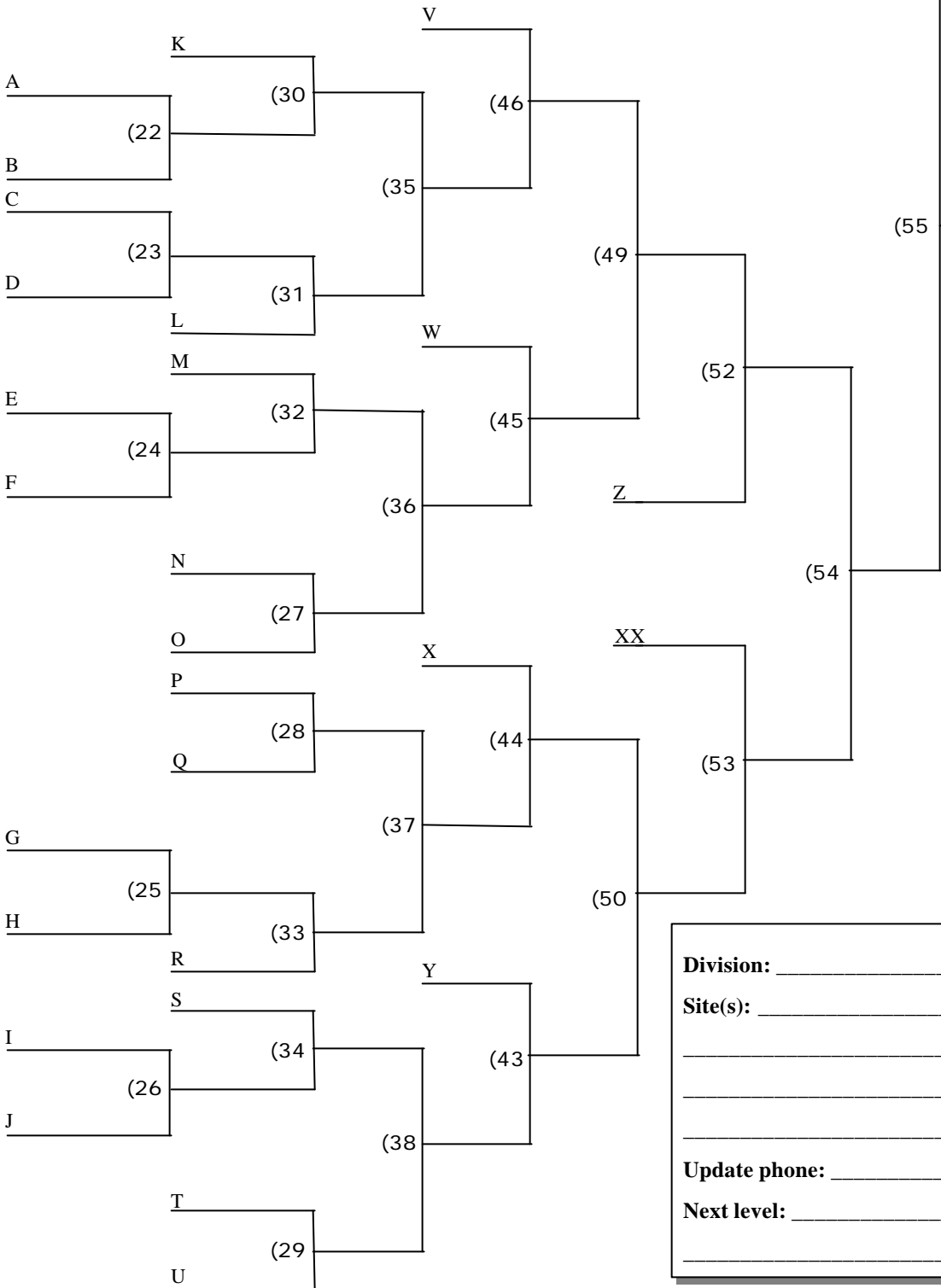

Winner advances to
Game 56
(previous page)

Division: _____
 Site(s): _____

 Update phone: _____
 Next level: _____

**Twenty Eight Teams
(Winners' Bracket)**

Division: _____

Site(s): _____

Update phone: _____

Next level: _____

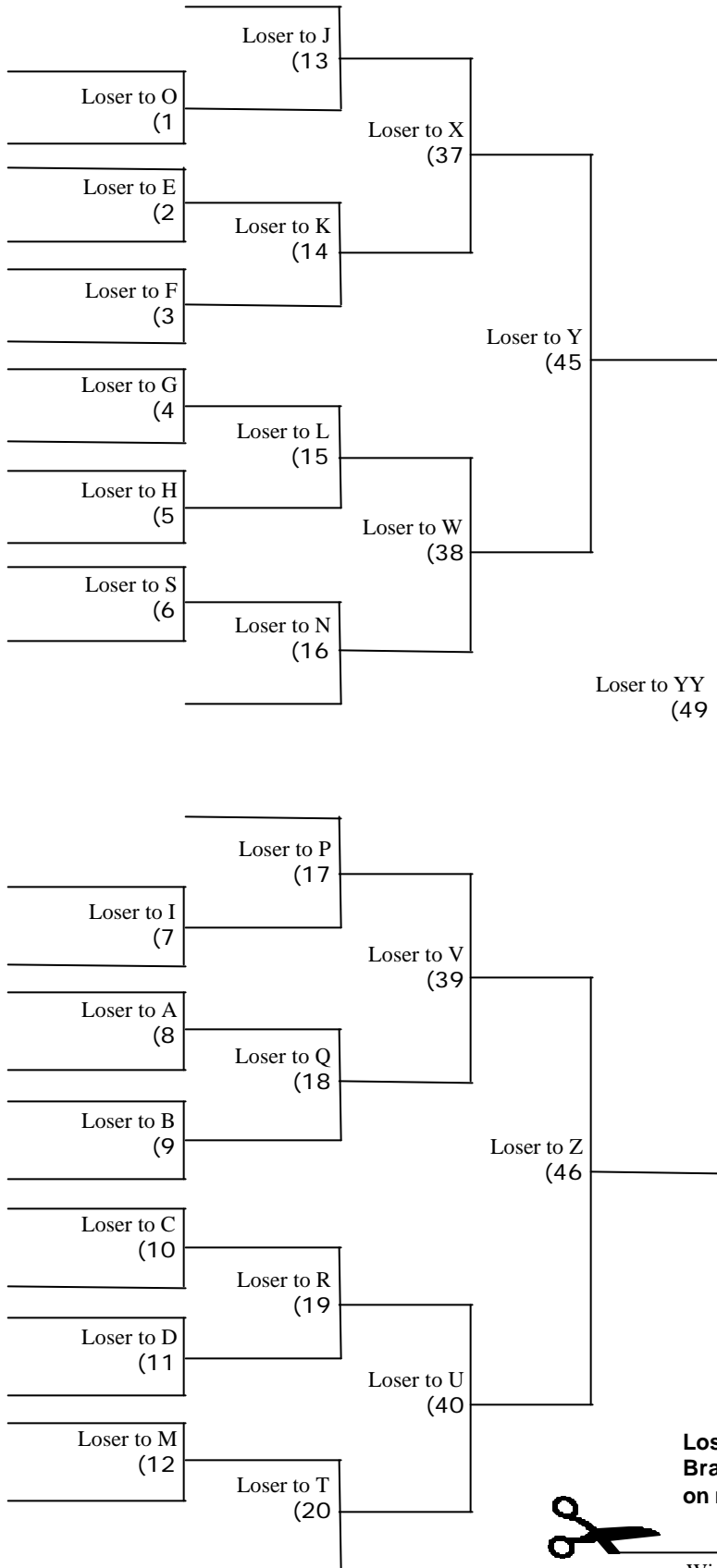

Little League Web Site:
www.littleleague.org

**Losers' Bracket
on next page**



Winner Game 53

Little League Web Site:
www.littleleague.org

**Twenty Eight Teams
(Losers' Bracket)**

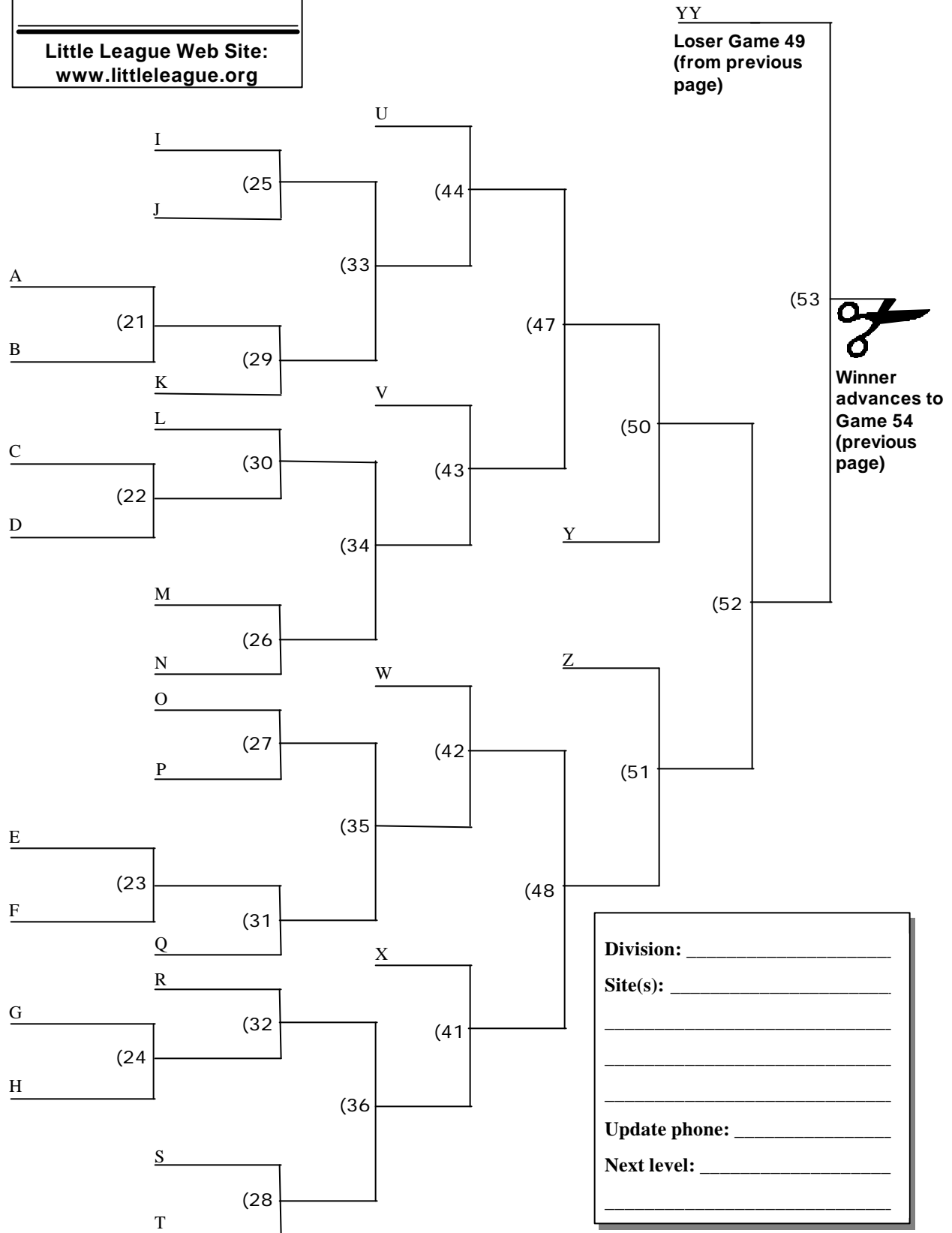

**Twenty Seven Teams
(Winners' Bracket)**

Division: _____

Site(s): _____

Update phone: _____

Next level: _____

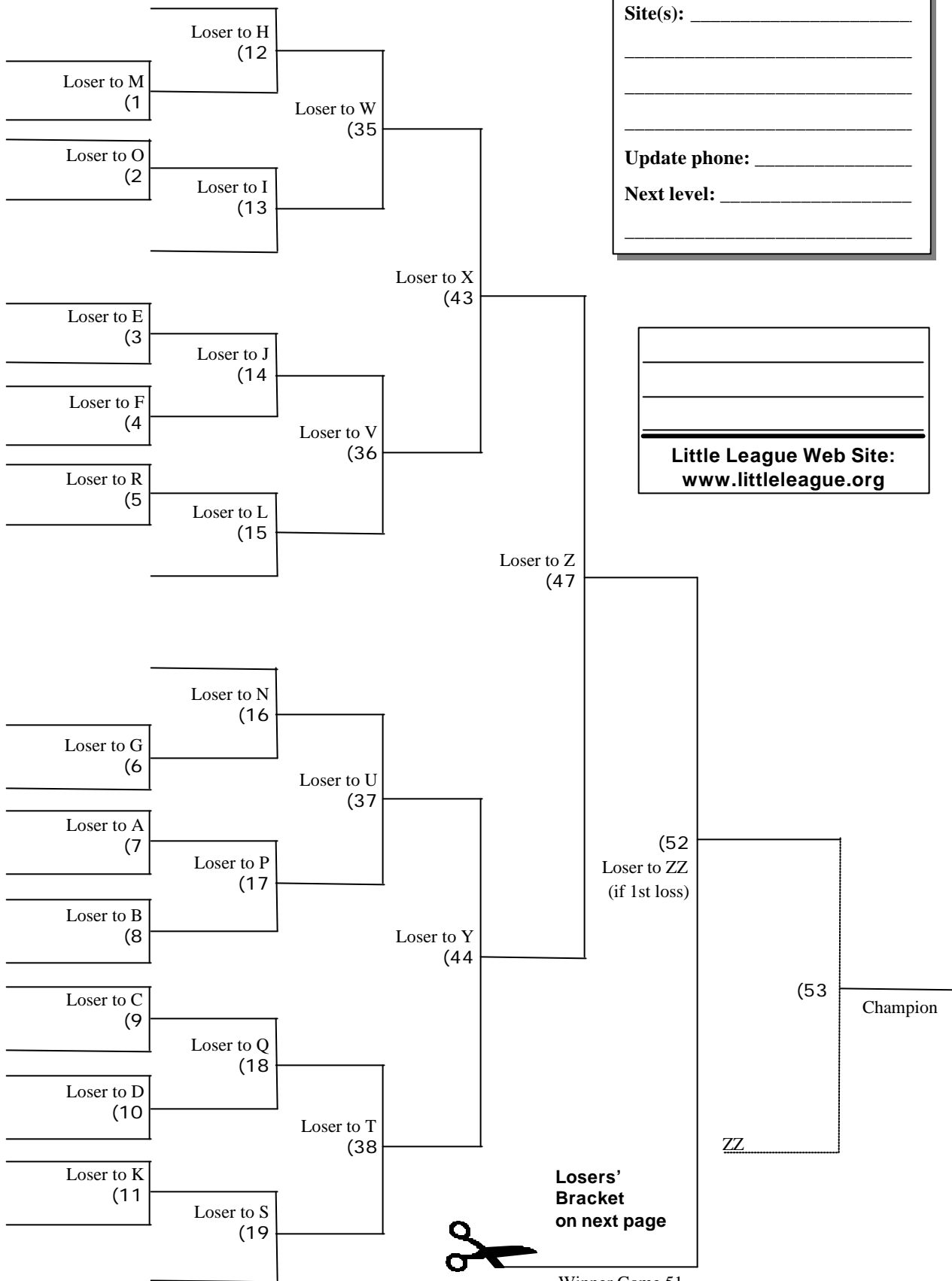

Little League Web Site:
www.littleleague.org

Winner Game 51

Little League Web Site:
www.littleleague.org

**Twenty Seven Teams
(Losers' Bracket)**

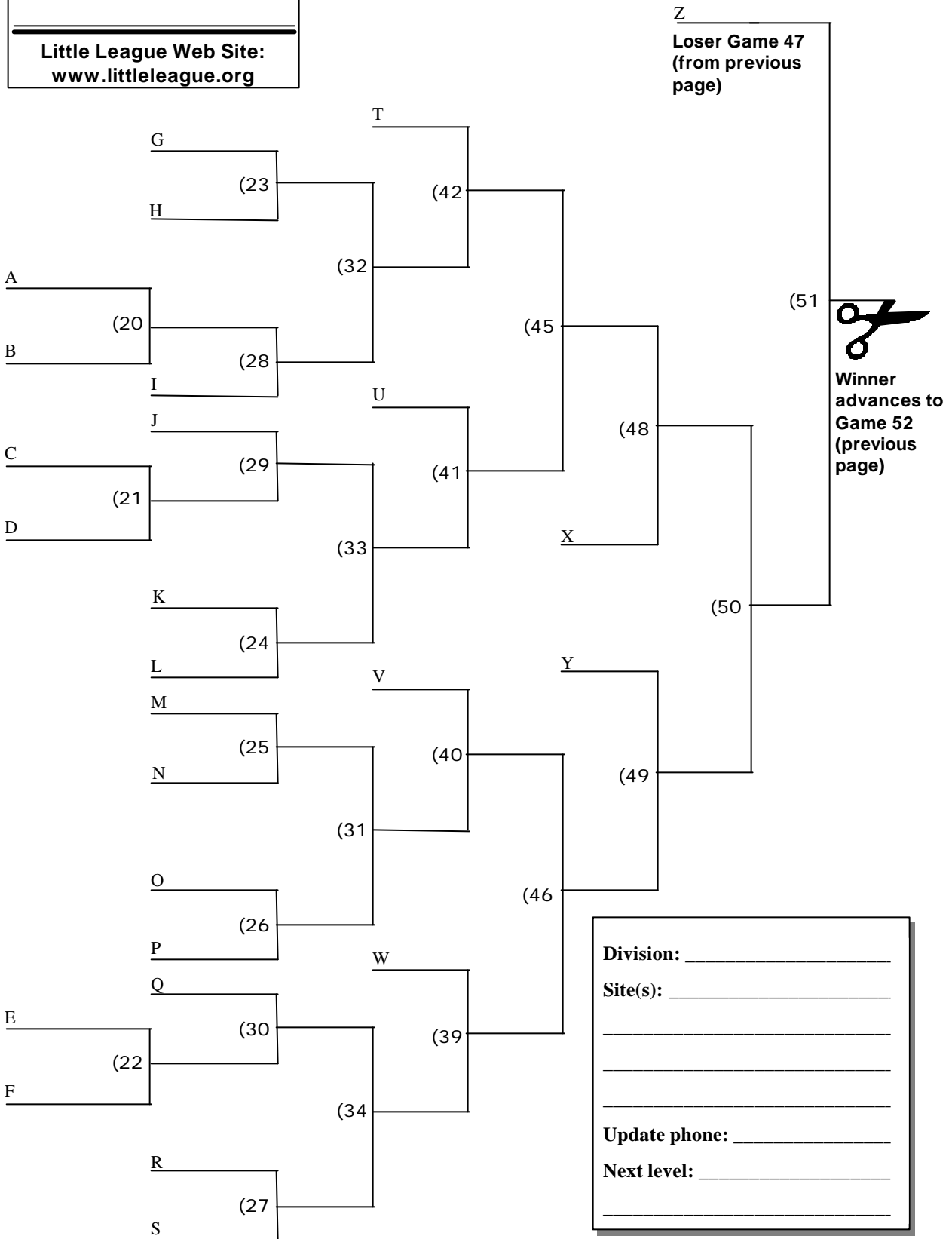

**Twenty Six Teams
(Winners' Bracket)**

Division: _____

Site(s): _____

Update phone: _____

Next level: _____

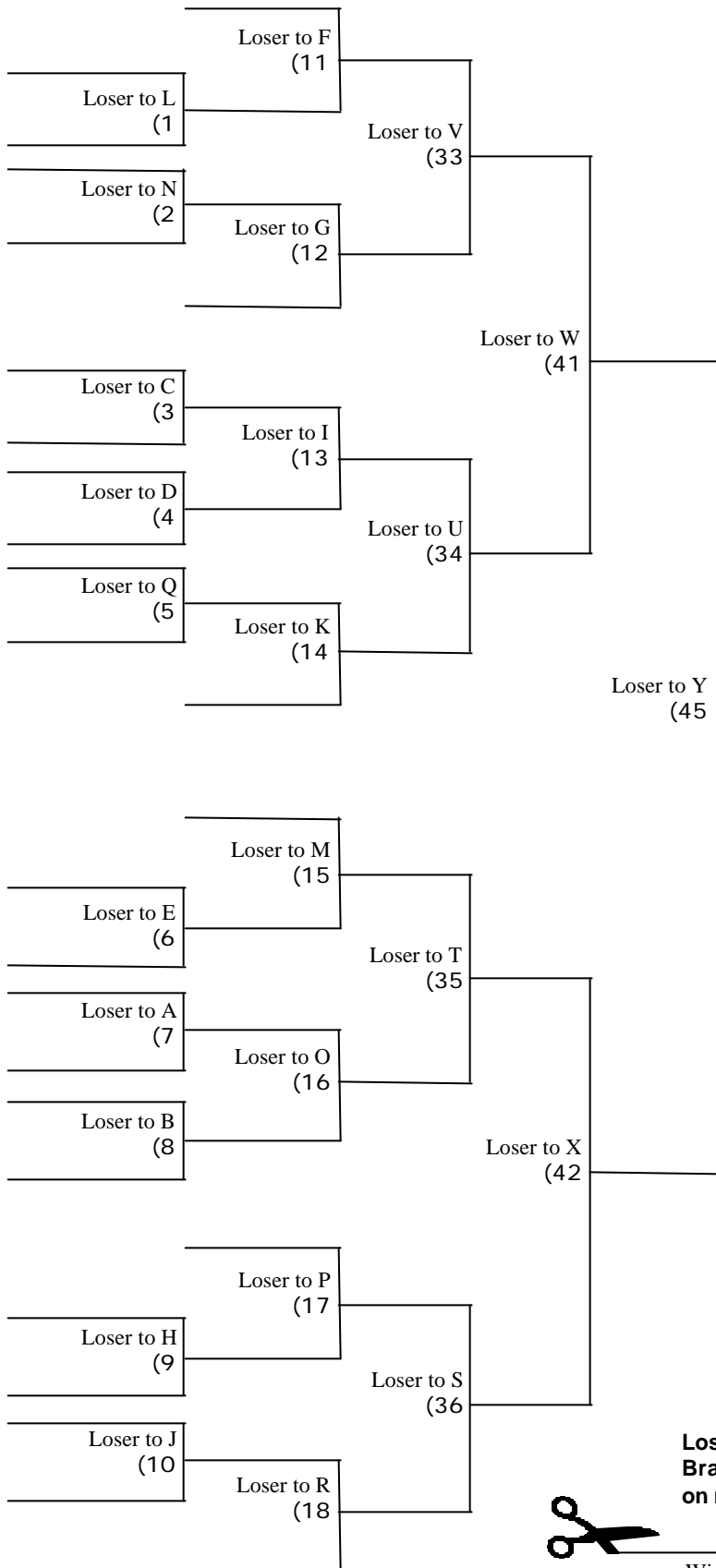

**Little League Web Site:
 www.littleleague.org**

**Losers'
Bracket
on next page**



Winner Game 49

Little League Web Site:
www.littleleague.org

**Twenty Six Teams
(Losers' Bracket)**

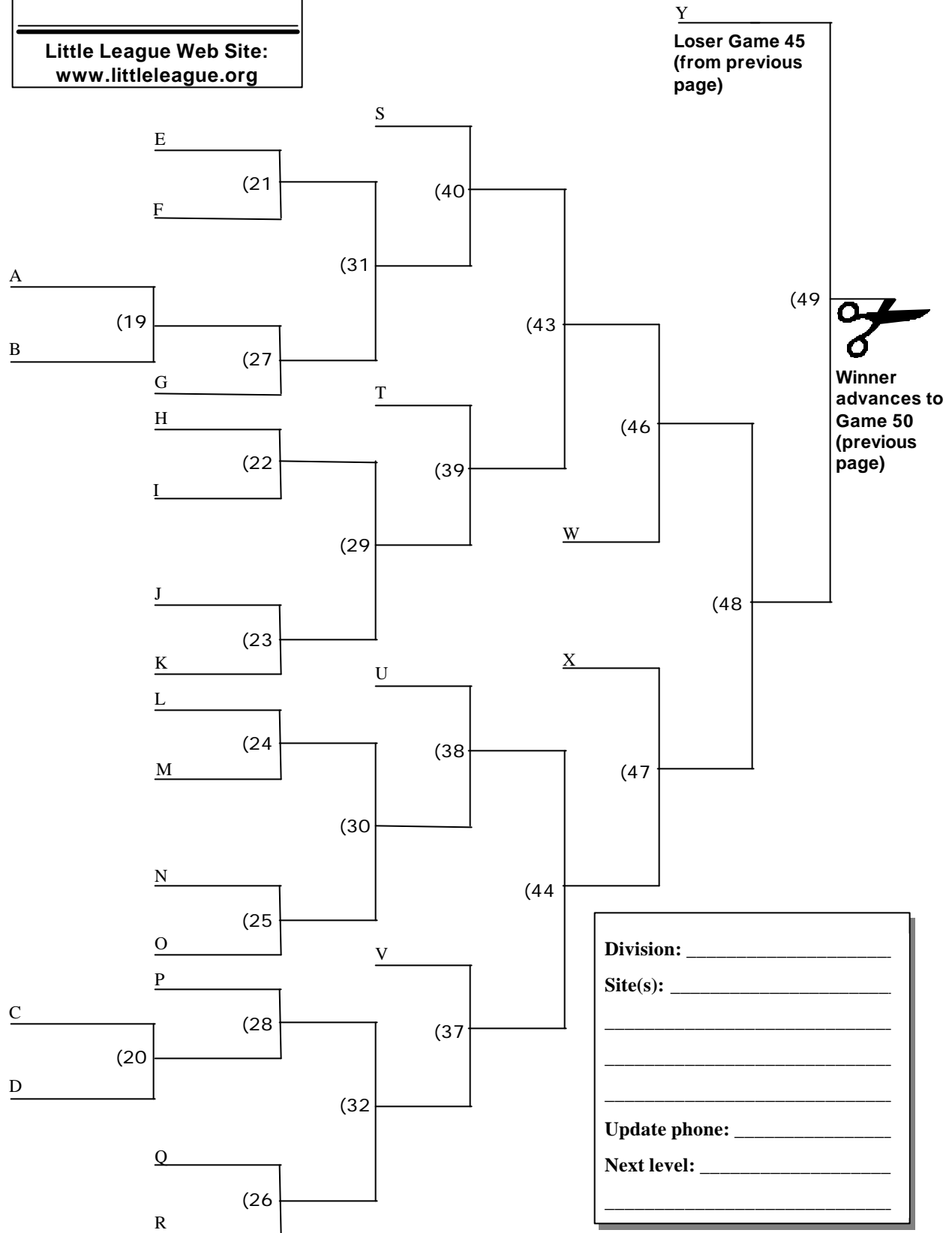

**Twenty Five Teams
(Winners' Bracket)**

Division: _____

Site(s): _____

Update phone: _____

Next level: _____

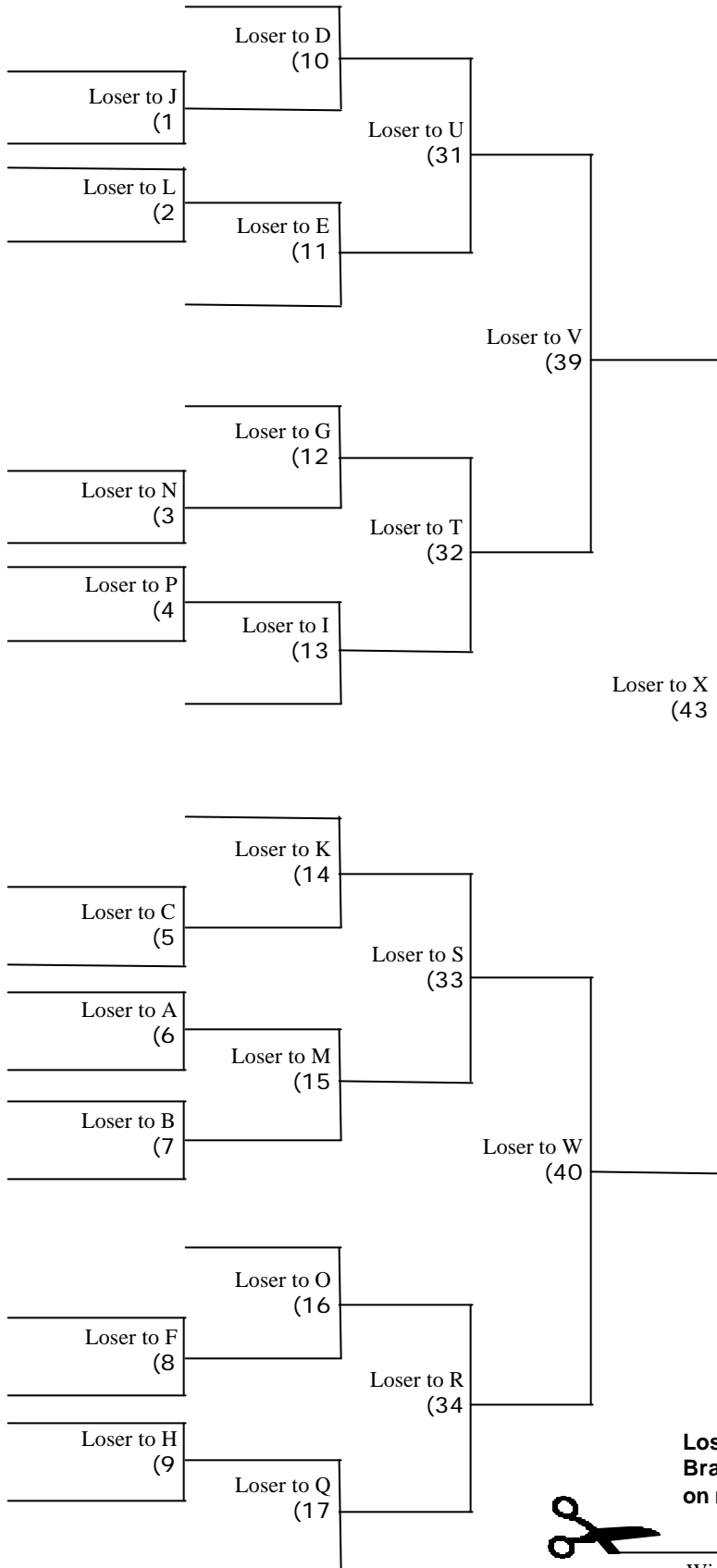

Little League Web Site:
www.littleleague.org

Little League Web Site:
www.littleleague.org

**Twenty Five Teams
(Losers' Bracket)**

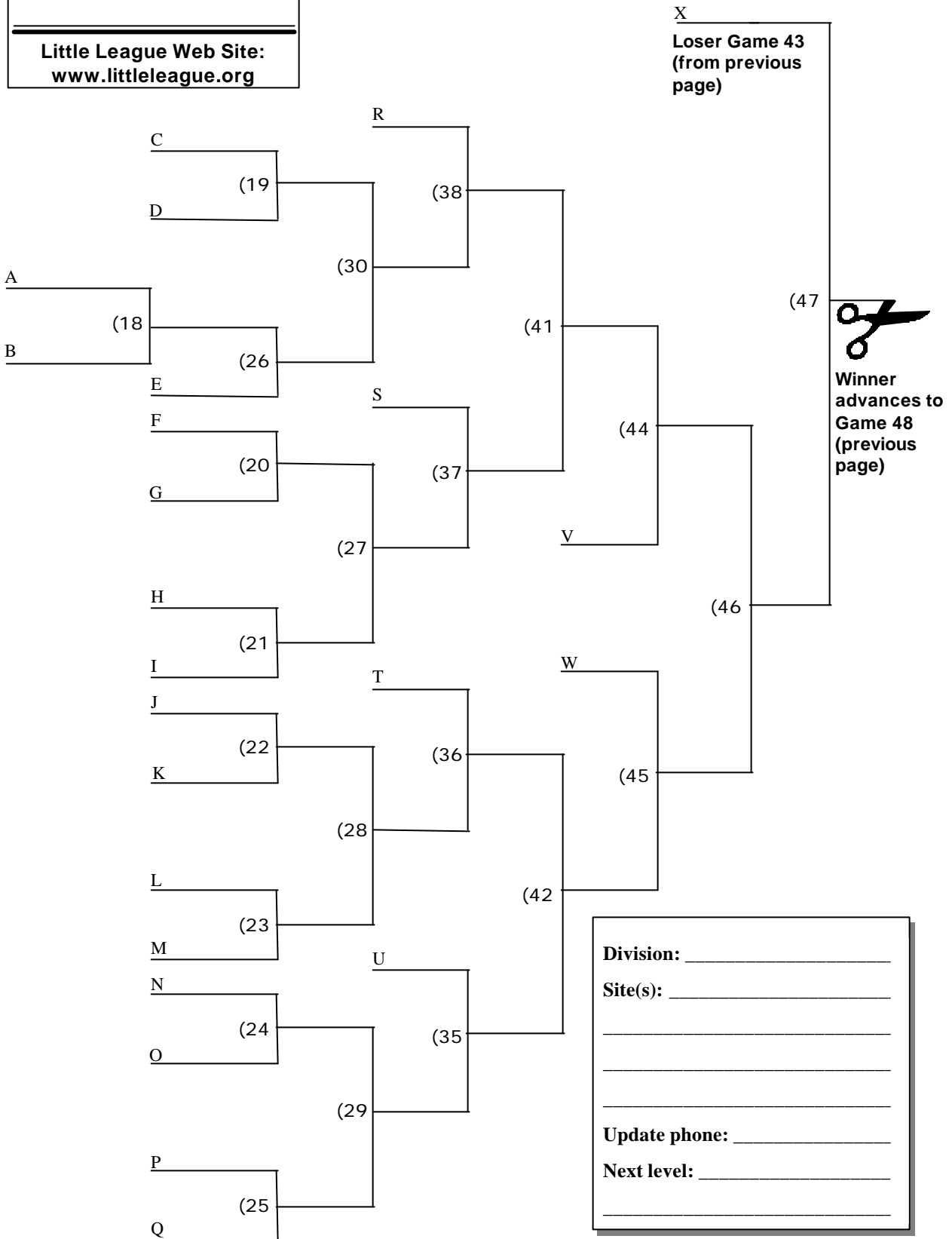

**Twenty Four Teams
(Winners' Bracket)**

Division: _____

Site(s): _____

Update phone: _____

Next level: _____

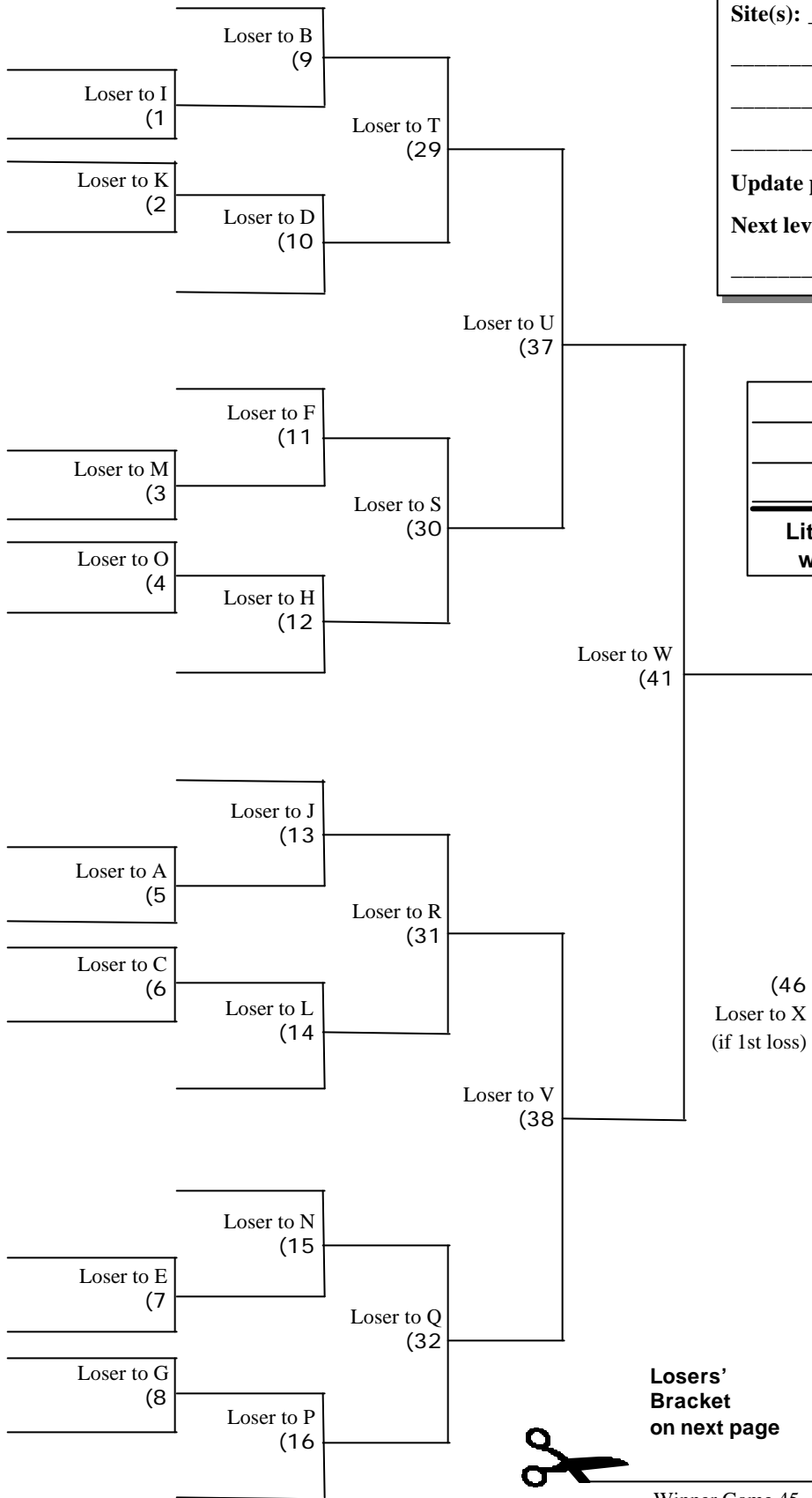

Little League Web Site:
www.littleleague.org



**Losers'
Bracket
on next page**

Winner Game 45

**Twenty Three Teams
(Winners' Bracket)**

Division: _____

Site(s): _____

Update phone: _____

Next level: _____

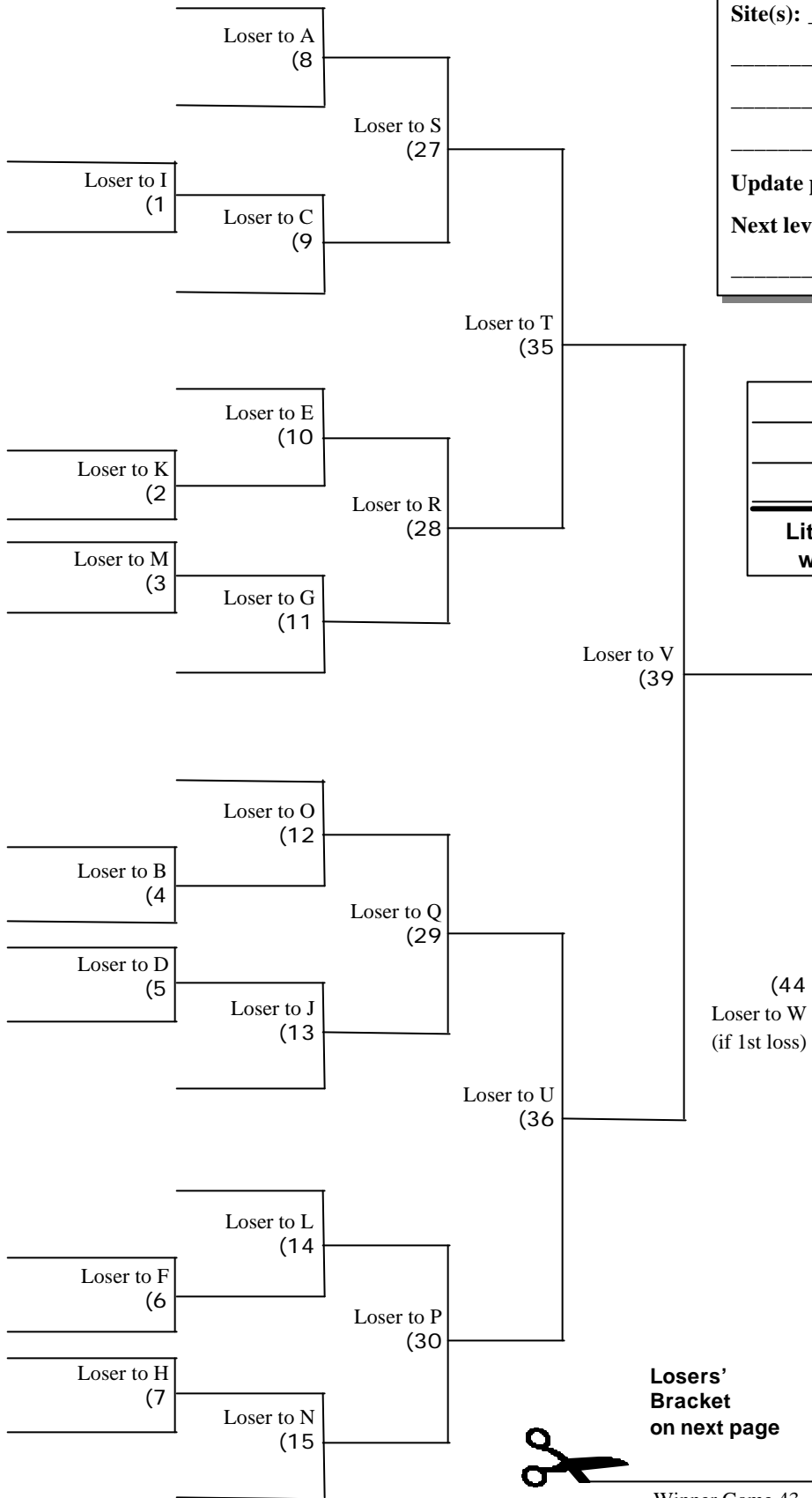

Little League Web Site:
www.littleleague.org

**Twenty Two Teams
(Winners' Bracket)**

Division: _____

Site(s): _____

Update phone: _____

Next level: _____

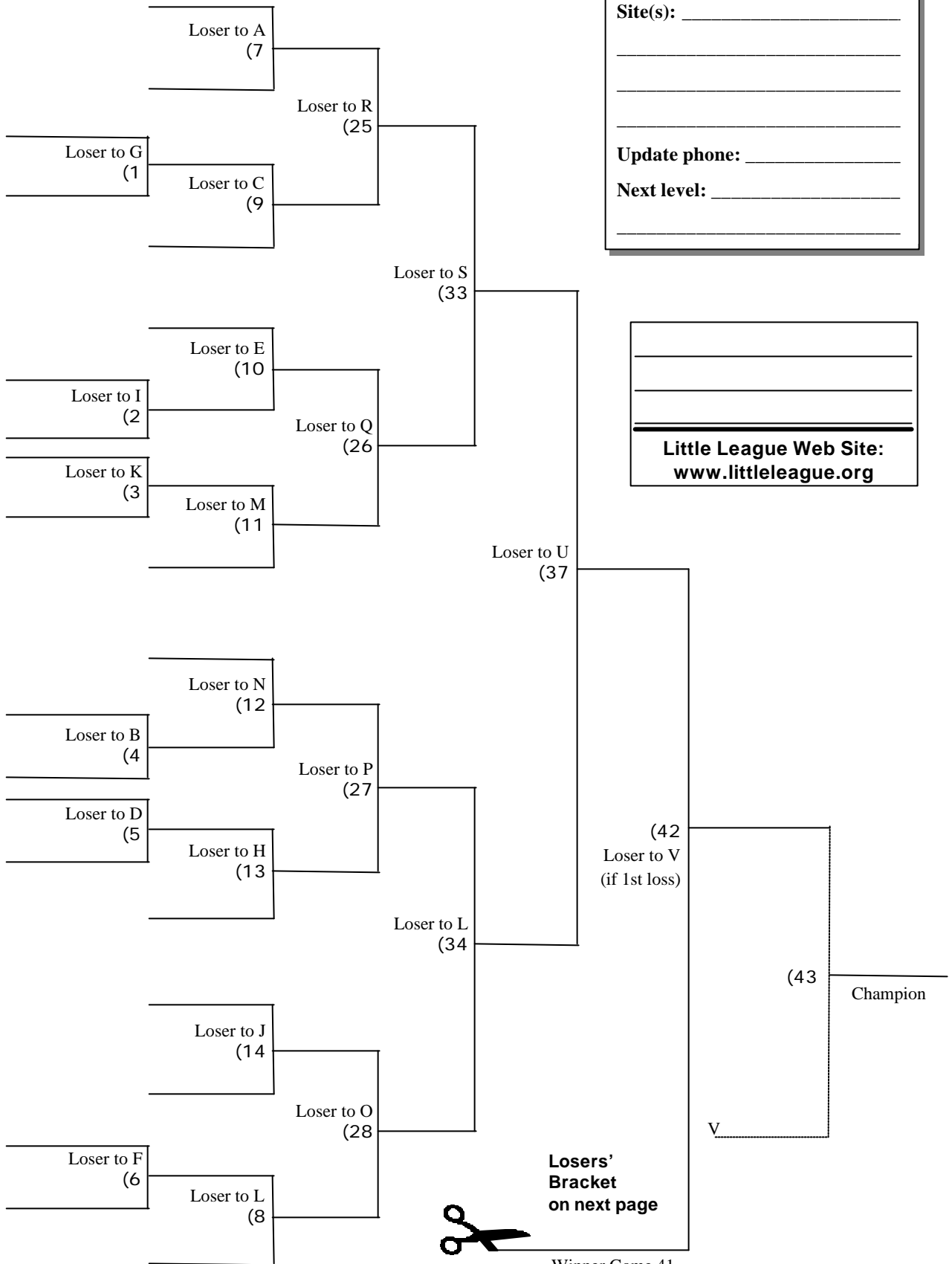

Winner Game 41

**Twenty One Teams
(Winners' Bracket)**

Division: _____

Site(s): _____

Update phone: _____

Next level: _____

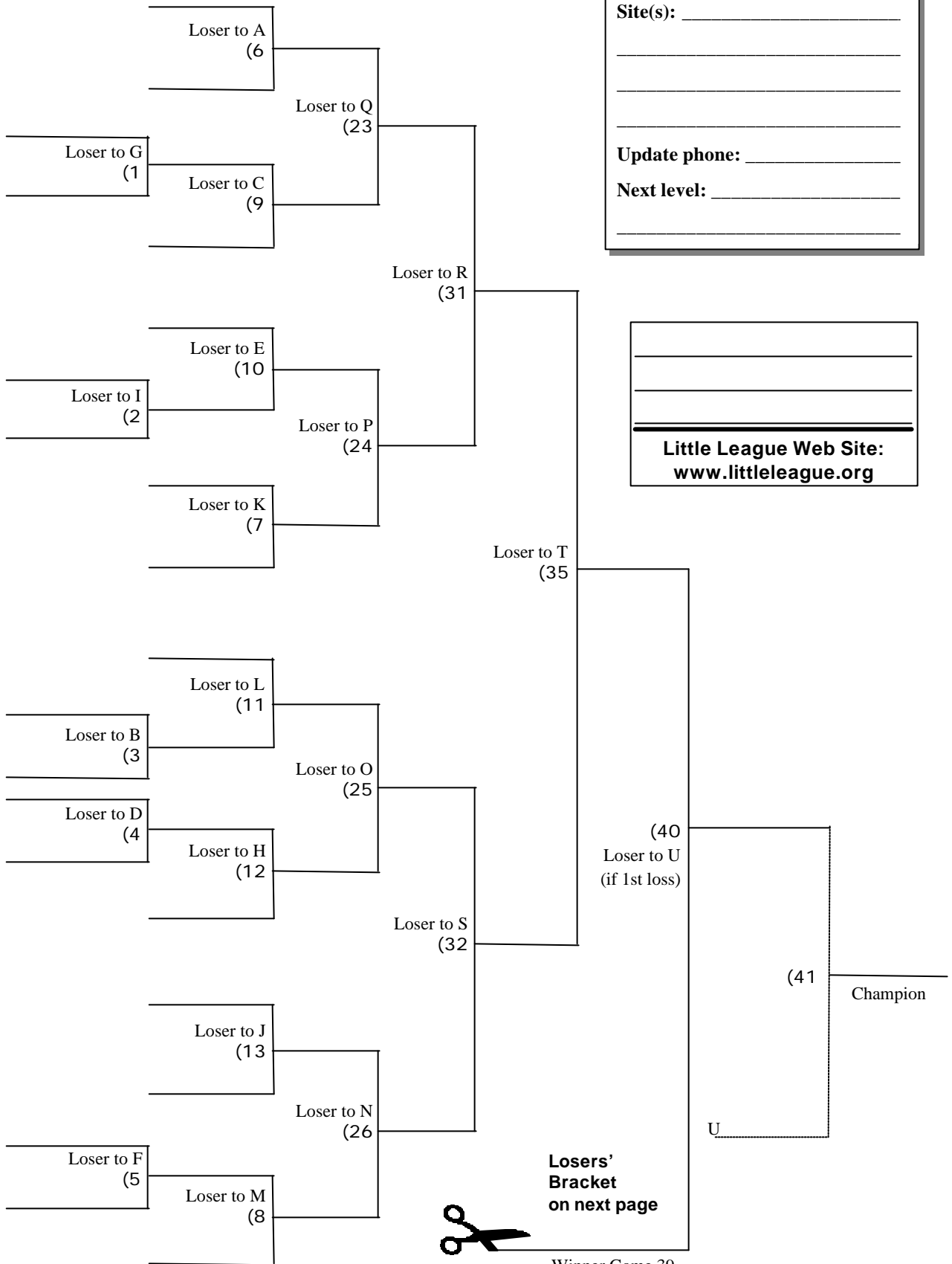

Little League Web Site:
www.littleleague.org

**Losers' Bracket
on next page**



Winner Game 39

Little League Web Site:
www.littleleague.org

**Twenty One Teams
(Losers' Bracket)**

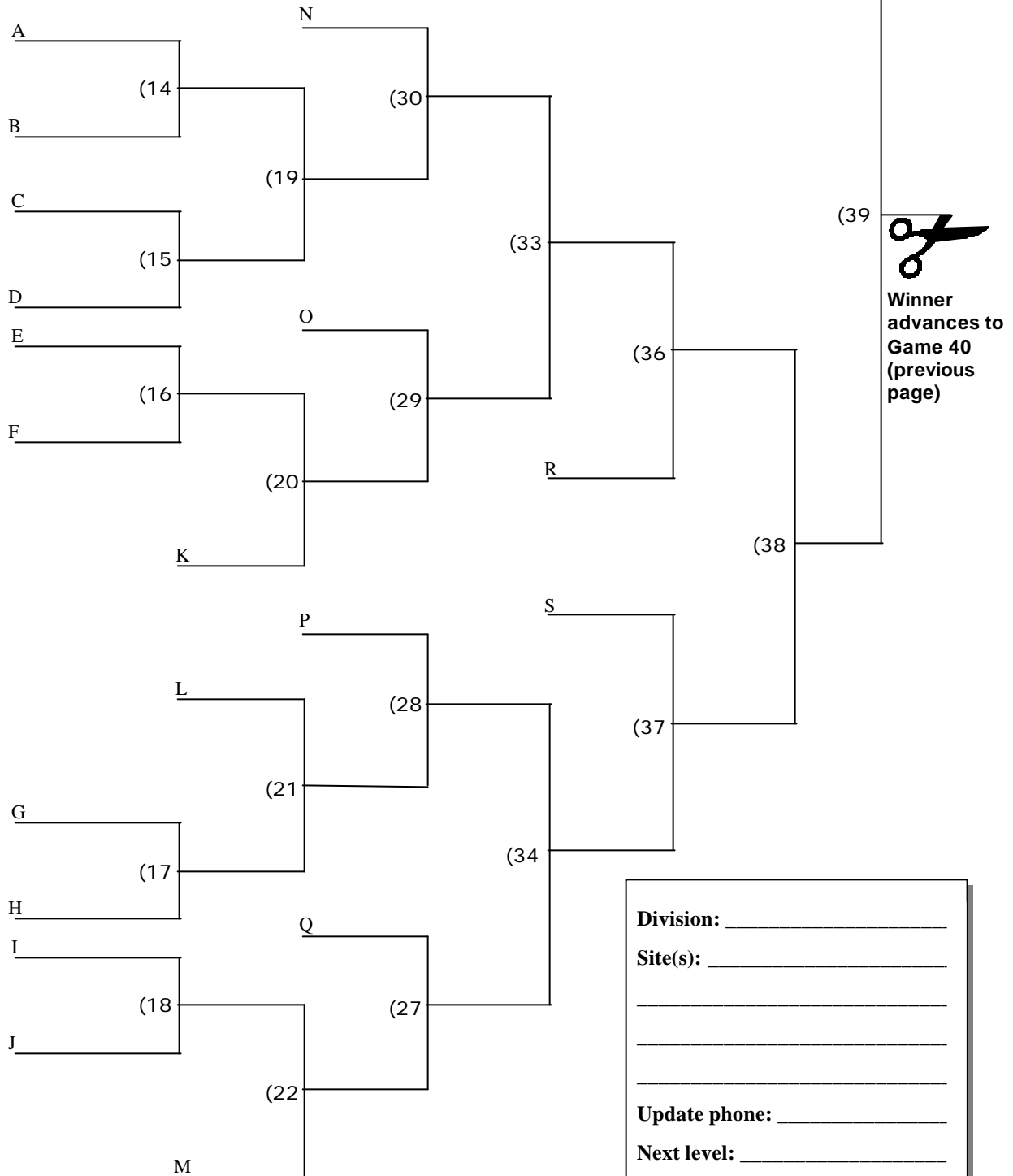

Division: _____
 Site(s): _____

 Update phone: _____
 Next level: _____
